

# CALYPSO

## CROSS BAR SAFETY COVER FOR POOLS



## **INSTALLATION AND OPERATION INSTRUCTIONS**

***To be read carefully and kept for future reference.***







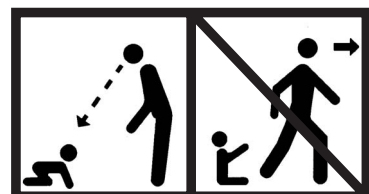

### IMPORTANT

- This cover is no substitute for common sense or individual responsibility. Nor is it intended to substitute the vigilance of parents and/or responsible adults which remains the key factor in ensuring the safety of young children.
- Caution: safety is only assured when the cover is closed, locked and correctly installed in accordance with the manufacturer's instructions;
- In the event of any absence, however brief, from the home, the cover must be installed systematically;
- Check that there is no person or foreign body in the pool both prior to and during this operation;
- Store the crank used to roll the cover up out of reach of children;
- The cover should only be rolled out or up by a responsible adult;
- Do not allow anyone to step on, walk on or jump on a safety cover;
- Implement all steps necessary to deny young children access to the pool while the cover is pending repair or during any malfunction preventing the pool from being closed and secured or in the event that the pool or equipment is unavailable.

- A pool can represent a serious danger to your children. A person can drown very quickly. Children near a pool require your constant vigilance and active supervision, even if they know how to swim.
- The physical presence of a responsible adult is absolutely mandatory when the pool is open.
- Memorise emergency numbers and display these close to the pool:
  - Fire brigade : (18 in France)
  - Medical emergency services : (15 in France)
  - Poison treatment centre
- **Learn first aid techniques.**

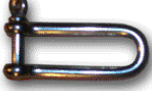

**ACCESSORIES DELIVERED WITH THE COVER**

	<b>Code and Designation</b>	<b>Use</b>	<b>Quantity, without stairs</b>	<b>Quantity, with stairs</b>	<b>Quantity for separate element</b>
	6409034 Peg with bushing Ø 6 mm	To hold the stair Fixkits	0	2 or 4 depending on stair width	2, 4 or 6 depending on the size of the element
	2396011 Fixkit	To attach the stairs	0		
	6409044 Peg with bushing Ø 8 mm	To hold the bar tension straps and the cable tension straps	10	12	3
	6409038 Sleeve, small	To protect the cam buckles on the bar tension straps	6	8	3
	6409037 Sleeve, large	To protect the ratchet buckles on the cable tension strap	2	2	0
	Cable tension strap	Cable tension	2	2	0
	Cable tension strap components: - 1 ratchet buckle code 6409030 - 1 one metre strap code 6409046 - 1 three-way buckle code 6409036 - 2 triangular rings code 6409032				
	Bar tension strap	Outer bar tension	6	8	3
	Bar tension strap components: - 1 cam buckle code 6409031 - 1 triangular ring code 6409032 - 1 three-way buckle code 6409036 - 1 one metre strap code 6409046 - 1 dumbbell shaped bar code 6409033				
	6409047 Dee shackle	To link the Ø 8mm peg with bushing and the cable, storage side	2	2	0
	6409035 Twisted shackle	To link the cable/ cable tension strap	2	2	0
	6409050 Crank	To roll up the cover	1 or 2 depending on the size of the cover		

**TOOLS REQUIRED:**

- Electric drill
- Tape measure
- Mallet
- Ø12 mm and Ø14 mm concrete drill bits
- Flat head screw driver

**NUMBER OF PEOPLE REQUIRED FOR INSTALLATION:**

Usually, two people are needed to carry the cover to the edge of the pool.  
The installation itself only requires one person.

**INSTALLATION TIME:**

Between 1 and 2 hours depending on the size of the pool.

**CLEANING METHODS:**

- Clean using a high pressure **cold water** jet: Keep the cleaning nozzle at least 40 cm away from the cover.
- Detergent - COVERNET (Code 8880505): spread the detergent on the cover and brush lightly. Allow it to act for 2 minutes and rinse with water.

## POOLS FEATURING LATERAL STAIRS - INSTALLATION OF A SEPARATE ELEMENT

IF THE POOL FEATURES STAIRS ALONG ONE OF ITS LENGTHS, INSTALL THE SEPARATE ELEMENT FIRST, OTHERWISE GO DIRECTLY TO THE INSTRUCTIONS ON THE NEXT PAGE.

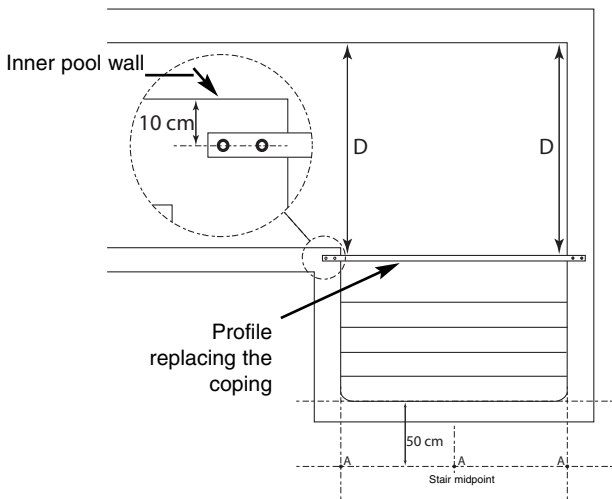

Place the separate component above the stairs. The axis of the profile replacing the coping should be 10 cm from the inner pool wall (diagram above). Also ensure that the dimensions "D" are identical so that the profile correctly overlaps the coping.

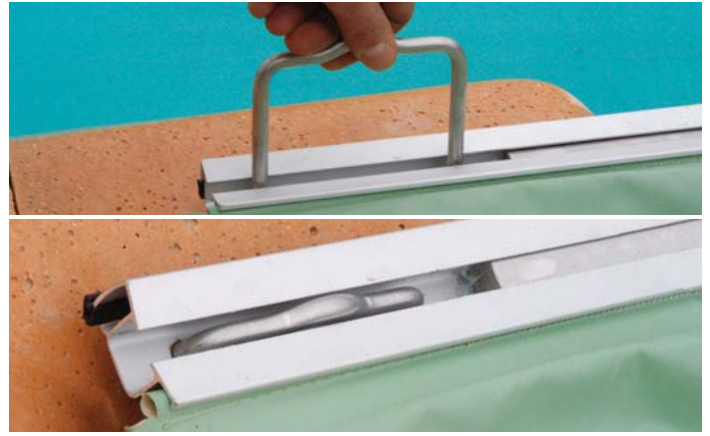

Use the profile replacing the coping as a template to drill two holes ( $\text{Ø}10\text{ mm}$ ) in the coping at each end. Attach the profile to the coping by inserting a retaining staple at either end as illustrated.

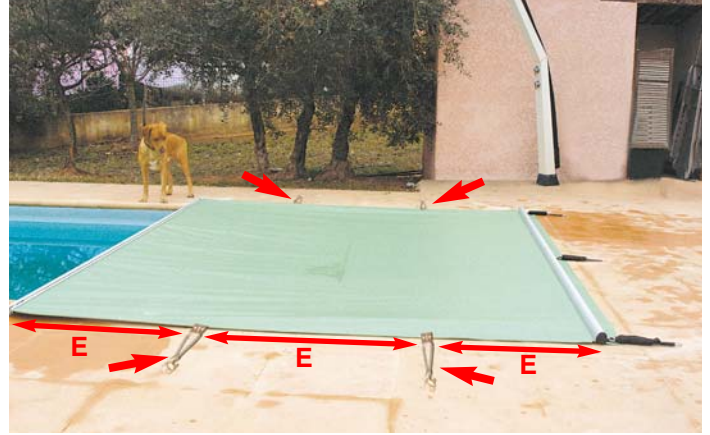

On the deck, mark the position of the 3 pegs with bushings that will hold the stair tension straps according to the diagram above.

Drill three holes ( $\text{Ø}14\text{ mm}$ , depth 70 mm) and drive a  $\text{Ø}8\text{ mm}$  peg with bushing into each hole. Attach a stair tension strap to each peg. Tighten the straps to tension the stair element. Slacken the tension on the central strap to avoid deforming the profile replacing the coping.

Position the Fixkit straps along each edge of the stair element. The distance between Fixkits (E above) should be between 50 and 70 cm.

Each Fixkit is held in position by a peg with bushing ( $\text{Ø}6\text{ mm}$ ) driven in 30 cm from the edge of the stairs.



## INSTALLING THE COVER

### CONDITIONS PREREQUISITE TO INSTALLATION:

- The area 100 cm around the pool must be cleared.
- Paving must be firmly fixed to the ground and laid on a concrete screed with a cement content of 350 kg/m<sup>3</sup>

THE STRAPS MAY BE SLID FREELY ALONG THE BARS DURING INSTALLATION TO ENSURE PERFECT ALIGNMENT WITH THE PEGS ON THE DECK.



1 Place the rolled-up cover along the width of the pool to be covered (on the side opposite the stairs or roman stairs, if any) .  
This side of the pool will be called the "storage side"



2 Centre the cover correctly with respect to the pool. From the opposite side, pull on the central strap to completely unroll the cover.

Center the cover on the coping.



If a separate element for lateral stairs has already been fitted, the cover will rest on the profile replacing the coping when the cover is unrolled.

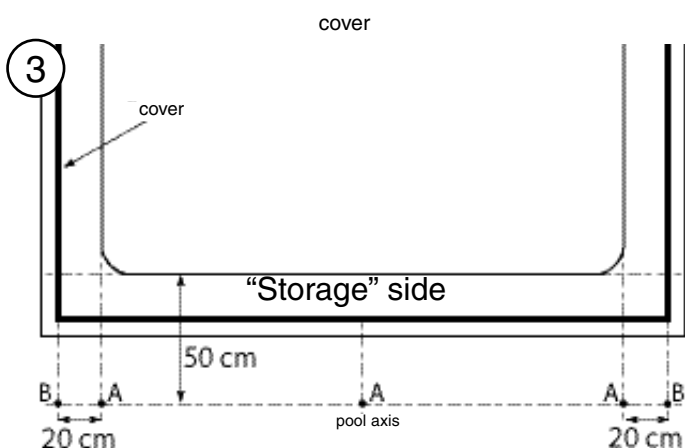

3 On the deck, mark the position of the first 5 pegs with bushing (3 for the straps and 2 for the cables) according to the diagram above. Dimensions indicated are measured from inside the pool.

- A = peg position for attachment of bar tension straps.
- B = peg position for attachment of cable tension straps

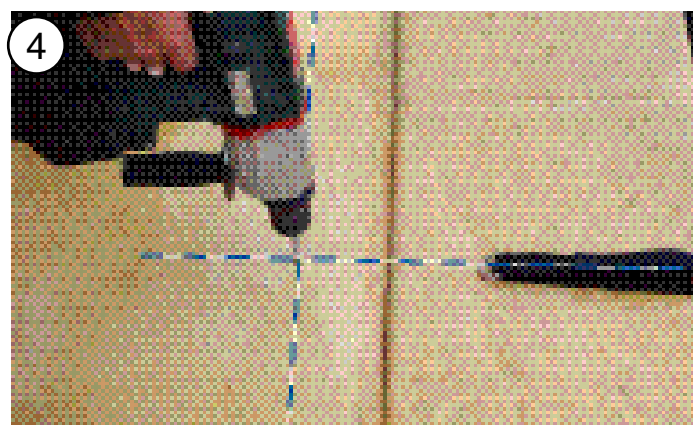

4 Drill holes for the Ø 8 mm pegs with bushing:  
- Ø 14 mm - depth 70 mm

Insert a Ø 8mm peg with bushing in each hole and drive home using a mallet.

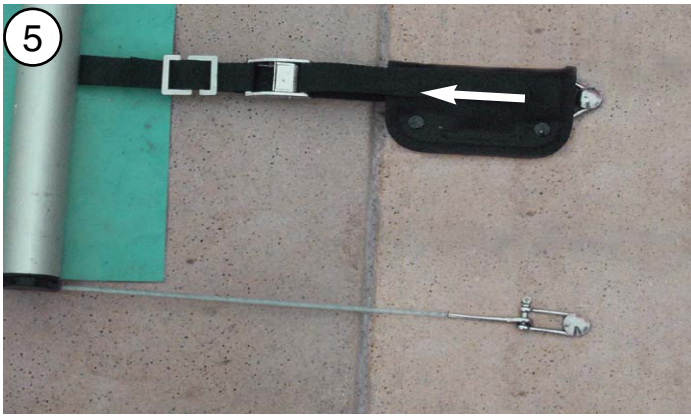

Slide small protective sleeves onto the straps. Hook the rings at the tips onto the cable tension strap and bar tension strap pegs. Shackle screws should be tightened to torque by an adult to ensure that they could not be loosened by a child. Adjust the bar tension strap buckles to ensure that the bar is parallel to the pool wall.

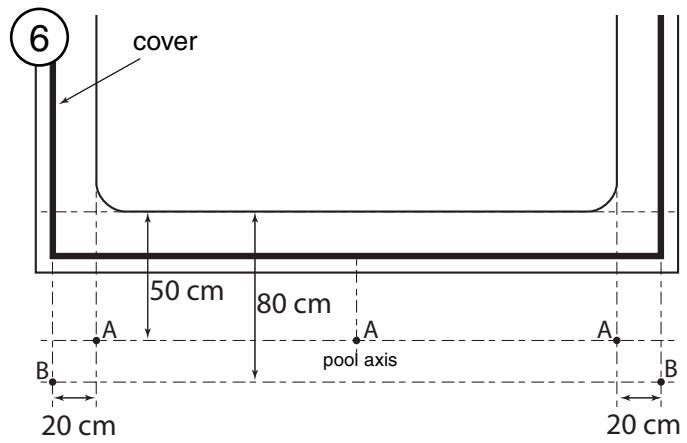

On the opposite side, mark the position of the 5 pegs as described previously. This time, the pegs holding the cables will be furthest from the pool edge (refer to the diagram above).

- A = peg position for attachment of bar tension strap.
- B = peg position for attachment of cable tension strap.

Drill holes and insert the pegs with bushings as laid out in step 4. Hook the straps on as described in step 5.

THE REST OF THE INSTALLATION PROCEDURE WILL TAKE PLACE ON THE OPPOSITE SIDE OF THE POOL.



- Slide a large protective sleeve onto each cable tension strap (7).
- Use the ratchet buckles to tension each cable (do not over tension, this could twist the peg with bushing).
- Hook the bar tension straps onto their respective pegs and tension. Apply the same tension to each of the three straps.
- Cover the ratchet buckles and cam buckles with the protective sleeves (8).

**POOLS FEATURING ROMAN STAIRS OR STRAIGHT STAIRS AT THE END OF THE POOL**

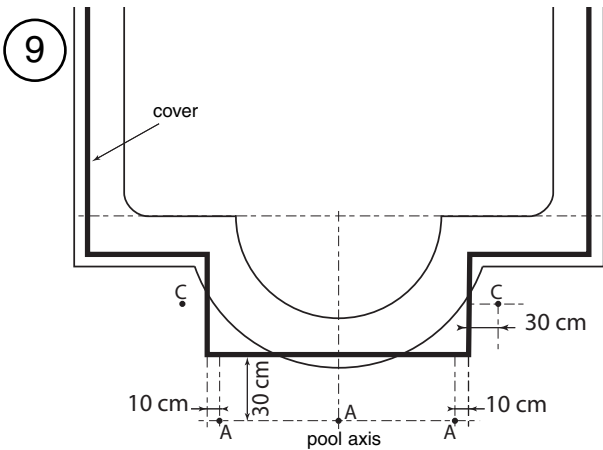

SLIDE THE STAIR EXTENSION WITH RESPECT TO THE COVER UNTIL IT IS PERFECTLY POSITIONED.

Follow the diagram illustrated above for pools featuring straight stairs or roman stairs.

- A = peg position for attachment of bar tension straps.
- C = Fixkit peg position. If the stair extension measures less than 1.40 m, no Fixkit will be placed in the middle. Above this measurement, other Fixkits will need to be positioned at regular intervals. The distance separating two Fixkits should be between 50 and 70 cm.

## USING THE COVER

**ALWAYS KEEP AN EYE ON THE POOL WHEN OPENING AND CLOSING THE COVER.**

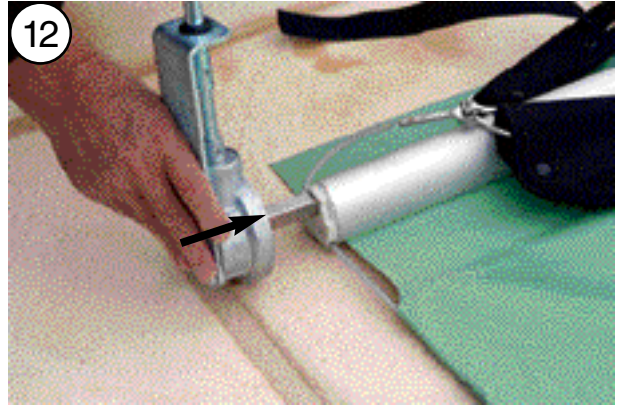

### ROLLING UP/ OPENING:

- Bring the long central strap down the middle of the pool to the storage side.
  - From the side opposite the storage side, loosen and release all the tension straps, cover the ratchet buckles and the cam buckles with the sleeves, fold these inside the cover and align them against the bar. Ensure that the pegs with bushings are correctly retracted into the low position. Insert the crank into the end of the drive shaft (side opposite storage side).
  - Turn the crank to roll up the cover. Ensure that the cover is rolled up as regularly as possible. If more resistance is met towards the end of the cover:
    - While turning the crank, tilt it towards the uncovered part of the the pool;
    - To facilitate rolling, pull the crank up vertically while holding it firmly and continuing to turn it if possible .
- Note :** for large pools (cover width greater than 4,90 m), a second crank will need to be placed at the other end of the bar and turned by a second person.

### UNROLLING/ CLOSING

- Pull on the strap to unroll the cover. Ensure that the cover unrolls correctly along the pool.
- Put the cable tension straps and bar tension straps into position and tension them.

### FOLLOWING INSTALLATION:

Check:

- that the straps are correctly tensioned and that the protective sleeves are in place.
- that the cover is correctly centred with respect to the coping.
- that there are no folds in the cover in contact with the coping as this would increase the risk of abrasion.

The long central strap used to unroll the cover may be removed (13) and stored if the cover is to be left on the pool for a long period of time.





## MAINTENANCE - COVER SURFACE

The user is entirely responsible for the upkeep of the CALYPSO cover.

### TO CLEAN THE COVER:

Cleaning methods:

- Clean using a high power **cold water** jet: Keep the cleaning nozzle at least 40 cm from the cover.
- COVERNET detergent (Code 8880505) : spread the detergent on the cover and brush lightly. Allow it to act for 2 minutes and rinse with water.

The CALYPSO cover must be cleaned regularly, **at least** twice a year. (At the beginning and end of wintering).

### DURING WINTER:

Every 15 days check:

- that rain water drains are not blocked by objects (leaves, branches, miscellaneous objects, etc.)
- that no unusual weight is exerting continuous and prolonged strain on the attachment systems. Remove any unusual accumulation (of leaves, water, snow, etc.)
- that all fasteners are correctly attached and in good condition to ensure that the cover is perfectly tensioned, a guarantee of a long service life and children's safety.

## MAINTENANCE-ACCESSORIES

### CHECK:

At least twice a year, (at the beginning and end of wintering), inspect the following items very carefully:

- bar tension straps
- cable tension straps
- pegs with bushing
- straight and twisted shackles
- cables
- coping pads

Replace any badly worn items that would be likely to prevent correct positioning of the cover immediately.

### PERIODIC REPLACEMENT:

The cable tension straps and bar tension straps should be replaced systematically every four years. Only authentic straps, which are mandatory, can guarantee safety.

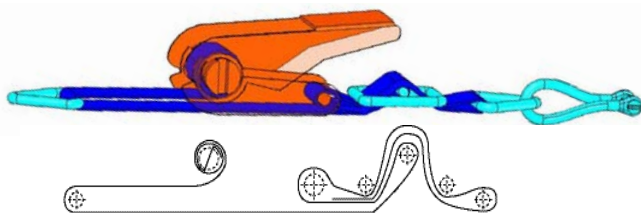

Cable tension strap routing.

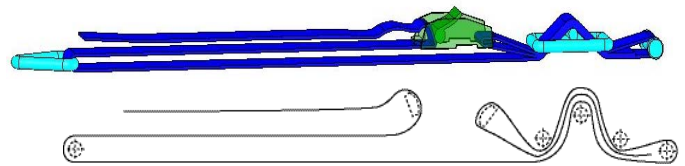

Bar tension strap routing

Dealer's stamp