

Operation Instructions

Compressor/Vacuum pumps

Models: D66-112015



Contents

1	Introductions			
	1.1	Application.....	23	4
	1.2	Vacuum and compression pressures.....	23	4
	1.3	Temperatures.....	23	4
	1.4	Specifications.....	24	5
2	Operation			
	2.1	Transport and storage.....	25	6
	2.2	Installation.....	25	6
	2.3	Electrical connection.....	29	10
	2.4	Commissioning.....	30	11
3	Maintenance			
	3.1	Cleaning.....	32	13
	3.2	Lubrication.....	33	14
	3.3	Parts list/drawing for single stage blowers.....	34	15
	3.4	Parts list/drawing for double stage blowers.....	35	16
	3.5	Bearings.....	36	17
	3.6	Troubleshooting.....	37	18
	3.7	EC-Declaration of conformity.....	38	19

1 Introduction

To ensure safe operation of your KleeBlower compressor/vacuum pumps, please read this instruction manual and pay particular attention to instructions marked with the following signs:



DANGER

Indicates an imminently hazardous situation which, if not avoided, will result in death or serious injury.



WARNING

Indicates a potentially hazardous situation which, if not avoided, will result in death or serious injury.



CAUTION

Indicates a potentially hazardous situation which, if not avoided, will result in minor or moderate injury.

1.1 Application

The KleeBlower is a complete unit ready for immediate installation either as a vacuum pump or as a compressor. It is designed for handling air and other non-flammable, non-corrosive and non-explosive gases only.

1.2 Vacuum and compression pressures

The drive motor can be loaded with total differential pressures given in the technical data. Blowers with limited performance curves in the high pressure range should be fitted with the relative pressure relief valves in order to avoid an overload of the motor. Pressure relief valves can be mounted directly on the outlet and the vacuum relief valves directly on the inlet of the blower.

1.3 Temperatures

The permissible ambient temperature and gas temperature at the inlet is -10 to +40 °C. The maximum allowed humidity is 80%

1.4

Specifications

Type no.	Power (kW)	Current (A) 400V 50Hz (1ph.230V50Hz)	Max. airflow (m ³ /hour)	Max. Vacuum / compression (mbar)	Noise level (dB)	Weight (Kg)
KB-129	0.18	0.52 (1.45)	48	50 / 60	53	6.5
KB-129L	0.18	0.52	48	50 / 60	50	6.5
KB-129	0.2	0.69 (1.5)	48	70 / 70	53	6.5
KB-229	0.4	1.2 (2.8)	84	110 / 130	58	11
KB-229L	0.4	1.2 (2.8)	84	110 / 130	58	11.5
KB-329	0.75	1.9 (6.5)	144	140 / 140	63	14.5
KB-329L	0.75	1.9 (6.5)	144	140 / 140	63	15
KB-329	0.9	2.4	144	165 / 180	63	15.5
KB-339	1.3	2.7	144	175 / 200	63	16
KB-429	0.9	2.4 (8.0)	216	130 / 130	70	20.5
KB-429	1.3	3.3 (9.5)	216	180 / 180	70	22
KB-429L	1.3	3.3 (9.5)	216	180 / 180	70	22.5
KB-429	1.5	(12.3)	216	210 / 220	70	22.5
KB-429	1.75	3.9	216	210 / 220	70	23
KB-429L	1.75	3.9	216	210 / 220	70	23.5
KB-429	2.2	4.5	216	220 / 270	70	26
KB-529	2.2	5.6 (16.7)	312	230 / 230	72	32
KB-529L	2.2	5.6	312	230 / 230	72	33
KB-629	3.4	7.2 (28)	312	260 / 280	72	35
KB-629L	3.4	7.2	312	260 / 280	72	36
KB-639	4	8.2	312	270 / 330	72	38
KB-729	5.5	12	552	270 / 300	74	78
KB-829	7.5	15.6	552	300 / 400	74	82
KB-919	9	21.4	1134	200 / 200	76	100
KB-929	13	30	1134	300 / 300	76	112
KB-939	20	44	1134	350 / 450	76	159
KB-2308	0.75	2.0	90	200 / 240	60	17
KB-3319	1.75	3.9	156	275 / 320	66	25
KB-3326	2.2	4.5	156	280 / 375	66	28
KB-4337	3.4	7.2	222	345 / 410	74	43
KB-4346	4.0	8.2	222	355 / 495	74	45
KB-6346	4.0	8.2	312	360 / 380	75	55
KB-6355	5.5	12	312	410 / 515	75	72
KB-6375	7.5	15.6	312	420 / 580	75	81
KB-6455	5.5	12	468	200 / 220	75	70
KB-6475	7.5	15.6	468	240 / 270	75	81
KB-8310	7.5	15.6	576	320 / 320	76	112
KB-8315	11	27	576	430 / 600	76	142
KB-8320	16	37.5	576	450 / 700	76	160
KB-8410	7.5	15.6	990	150 / 150	76	110
KB-8415	11	27	990	260 / 260	76	140

2 Operation

2.1 Transport and storage

When lifted by a crane, Kleeblower units must be secured at the eye bolt on the pump casing.

Pay attention to the load-bearing capacity of the hoisting equipment. See previous page for weight data.

The rolling contact bearings should be regreased or enclosed. They should be replaced with new ones if more than four years have elapsed between delivery and machine commissioning under favourable circumstances (storage in a dry, dust free and vibration free room). Under unfavourable circumstances, this period is considerably reduced.

2.2 Installation

A)

Kleeblower units can be installed in vertical, horizontal or slantwise position. However take bearing load into consideration when installing the blower: The following examples are for your reference:

CORRECT

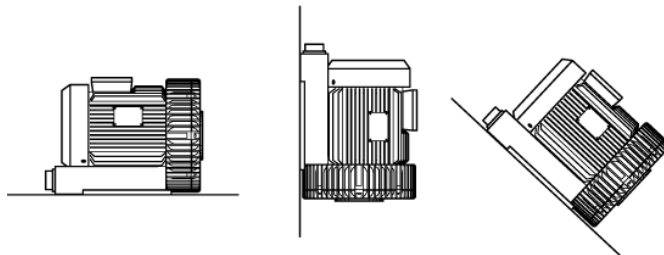

INCORRECT

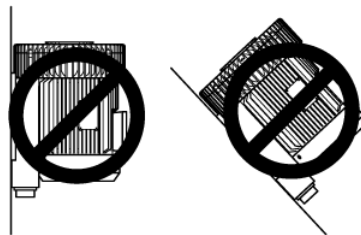

B)

An awning is required for the blower if it is installed outdoors, avoiding motor from being damaged.

C)

The base with which the blower is fastened must be 3 times as heavy as the blower.

2.2 Installation continued

D)

Install a filter onto the suction inlet of the blower to prevent it from sucking impurities if the suction inlet is not connected to a pipe.

E)

Keep ventilation gratings and openings clear. The direction flow is indicated by arrows on the motor end shield and casing.



WARNING On installation or after maintenance, it is needed to check that the pump rotation is correct as specified by the arrows.



WARNING Do not operate the blower with the inlet or outlet blocked or restricted, direct or via nozzles.

F)

Piping needs to be installed to the same level as the central line of the blower outlet and inlet.

G)

Piping needs to be installed without becoming narrowed, expanded or being bent at 90 degrees to avoid affecting blower's operation efficiency.

H)

Piping needs to be fastened independently. Do not mount the piping to the blower flange or casing to avoid damaging the blower.

I)

The sectional-area curve of the pipe diameter should be no less than 60% of the sectional-area curve of the blower outlet.

J)

Since the pressure and current of the blower are in direct proportion, it is necessary to enlarge the diameter of the wind suction/extraction piping to avoid overloading of the motor.

K)

Keep the fan motor of the blower away from walls or any stuff at a distance of 50mm to avoid affecting the heat dissipation efficiency of the motor, preventing it from overheating.

2.2 Installation continued

L)

Since the pressure and current of the blower are in direct proportion, it is necessary to install a pressure relief valve at the air suction/extraction port to avoid overcurrent failure of the motor. The pressure relief valve listed below can be used in both compressor and vacuum applications.

Mounting:

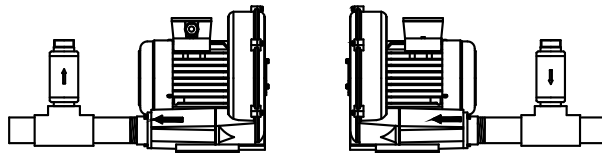

Outline:

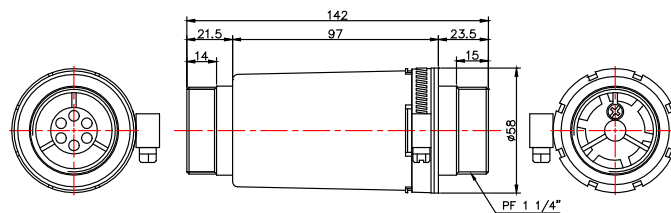

Type	Thread	Interval
RV-01	PF-1 1/4 "	0 ~ 300mbar
RV-02	PF-1 1/4 "	0 ~ 600mbar

M)

Pressure and air friction can easily build up heat around the outlet of the blower. To lead away the heat, an iron pipe at minimum 1 meter is thus needed to be connected to the outlet.

N)

On the discharge side, the cover, impeller and silencer housing must not come into contact with flammable materials (i.e. wood)

O)

The flow noise is reduced by build-in silencers. In the case of free air intake or exhaust, the noise can be further reduced by attaching additional silencers. In order to reduce noise emission even further, these units should not be attached to components that conduct or radiate sound (such as thin walls, metal plates etc.). If necessary provide intermediate sound-absorbing layers.

2.2 Installation continued

L)
Serial and parallel connected blowers feature:

Serial connection: (Pressure increases)

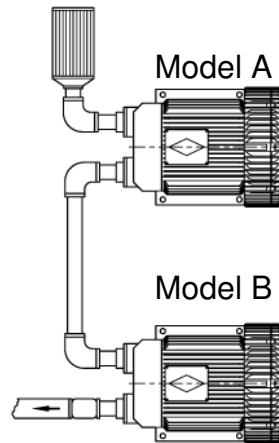

Pressure = 90% of (Model A + Model B)
Air flow = Model A

Parallel connection (airflow increases)

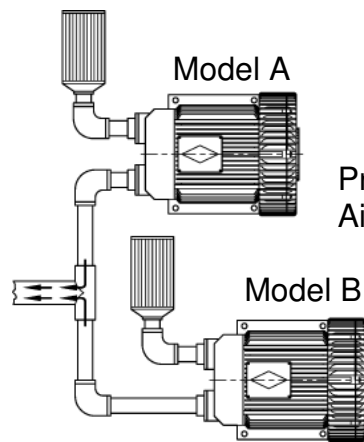

Pressure = Model A or Model B
Air flow = Model A + Model B



CAUTION

Blowers of different horse power can not be connected with one another.

**DANGER**

The electric power must be disconnected before any work is performed on the equipment.

A)

The system voltage and frequency must be the same as stated on the stamp plate. $\pm 5\%$ voltage and $\pm 2\%$ frequency deviations from the rated values are permitted without the necessity of derating the output. The joints should be arranged and connected according to the circuit diagram in the terminal box. The protective earth conductor should be connected to the \equiv terminal

**CAUTION**

High surface temperatures of more than 70°C can occur at the blower. No heat-sensitive parts, such as standard cables or electronic components, must be attached or make contact to the surface. If necessary, protection measures must be provided!

B)

The rated motor current applies for $+40^{\circ}\text{C}$ air inlet and ambient temperatures. However at temperatures of $+25^{\circ}\text{C}$ a 6% higher motor current is permissible.

C)

Select motor circuit-breakers to match the rated motor current. Where frequency drives are used as power supply, high frequency current and voltage harmonics in the motor cables can cause electromagnetic interference. Therefore shielded motor cables are recommended.

D)

Exceeding the operating speed (see stamp plate) worsens performance with respect to noise and vibration, and also shortens the life of bearing grease and the bearing replacement interval. To prevent damage arising from excessive speeds, it is advisable to consult the supplier concerning speed limits. Generally rule is approx. 65Hz maximum.



CAUTION

If the blower is started up without being connected or fastened, for example for test purpose, the initial torque of the motor may cause suddenly movement resulting tilt of the blower.

Note: for safe operation of the blower the following conditions as a minimum must be observed:

A)

The blower is assembled and operated in accordance with the data on the stamp plate and information supplied by this manual. (voltage, current, frequency, connection model and type of protection)

B)

When frequency drives are used, operating speeds are not to be exceeded according to permitted data on stamp plate. Generally rule is approx. 65Hz maximum.

C)

The blower is properly assembled, aligned and connected to piping or hoses as appropriate.

D)

The elevation of the installation location is taken into account when adjusting the pressure control valves

E)

The direction of the rotation of the blower is as specified.

F)

All fastening screw/bolts, fasteners and electrical connections are tightened.

G)

The earthing and equalizing potential bonding connections have been made properly.

H)

All measures have been taken to protect against contact with moving or energized parts.



CAUTION

The inlet must be arranged so that no foreign elements are sucked in and ejected through the outlet. (hazard for eyes and skins)



CAUTION

When air is sucked in from the atmosphere, the inlet must be covered with protective devices (i.e. gratings) in order to prevent foreign elements including parts of the body and clothing being sucked in.



DANGER

Covers which prevent contact with active or rotating parts are not to be opened during operation.

3 Maintenance



DANGER

Before any work is performed on the blower or equipment, especially covers over moving parts are removed, the blower should be properly disconnected from the power supply or frequency drive. Wait until the rotation of the blower is stopped completely.



DANGER

Do not connect the power supply or frequency drive until the blower has been completely assembled.

3.1 Cleaning

A)

When there are any deposits of fluff or dust, clean the entire surface of the KleeBlower unit.

B)

When required by operating conditions, dismantle by removing screws or nuts from blower cover. Do not lose these nuts; they will be required for reassembly! Remove and clean the cover. Clean impeller and housing after carefully covering rolling-contact bearing. Reassemble in the reverse order.



WARNING

After fastening screws/bolts are removed, some parts are just in centring fits. Even during proper dismantling it is still possible that some heavy parts suddenly become loose and drop off, possibly causing injuries and damage. Take suitable measures to secure all parts being worked on.

3.2

Lubrication

A)

The following applies in connection with normal operating conditions (air intake and ambient temperatures +40°C max. and permissible total differential pressure): After approximately 20.000 hours of operation or after two and a half years at the latest, the rolling-contact bearings and adjacent spaces should have the old grease removed and be recharged with new grease. About 50% of the free space in the rolling-contact bearings and about 65% of the adjacent grease spaces should be filled with grease.

B)

Closed rolling-contact bearings should be replaced with new ones; their adjacent grease spaces are not filled with grease.

C)

The information given concerning bearing life and grease life applies to only this product. Always avoid mixing different types of greases.

D)

Type of grease used in bearings is Mobilgrease XHP220

3.3

Parts list/drawing for single stage blowers (KB129-KB939)

ITEM	PART NAME	ITEM	PART NAME	ITEM	PART NAME	ITEM	PART NAME
01	Compressor Cover	04	Rotor	08	Fan	12	Upper Terminal Box
01-1E	Front Bearing Cover	04-1	Key	09	Fan Cover	12-1	Rubber Gasket (Upper)
01-2E	Nipple	04-2	Oil Seal	10	Base	13	Silencer Mesh
02	Impeller	04-3	Felt Ring	10-1E	Support	14	Silencer Foam
02-1	Inner Bearing Cover	05	Stator & Coil	11	Under Terminal Box	15	Silencer Casing
02-2	Front Bearing	06	Motor Housing	11-1	Cable Gland	15-1	Silencer Gasket
02-3	Disc	06-1	Sponge Filler	11-2	Rubber Gasket (Under)	16	Inlet / Outlet
02-1E	Bearing Socket	06-1E	Bracket	11-3	Terminal Board	16-1	Inlet (Outlet) Gasket
03	Compressor Housing	06-1S	Capacitor Bracket	11-4	Board Base	16-3	Inlet (Outlet) Plug
03-3	Bronze Ring	06-2S	Capacitor	11-5	Wire Connection	16-1E	Inlet (Outlet) Plate
03-1L	Middle Motor Cover	06-3S	Steel Clip	11-6	Nut	16-2E	Inlet (Outlet) Cover
03-2L	VA-Seal	07	Motor Cover	11-1E	Plug	Parts not listed are standard ones, e.g.nut,screw, washer	
03-3L	Front Bearing WP	07-1	Rear Bearing	11-2E	Steel Plate		
03-4L	Bearing Washer	07-2	Wave Washer	11-3E	Rubber Ring		

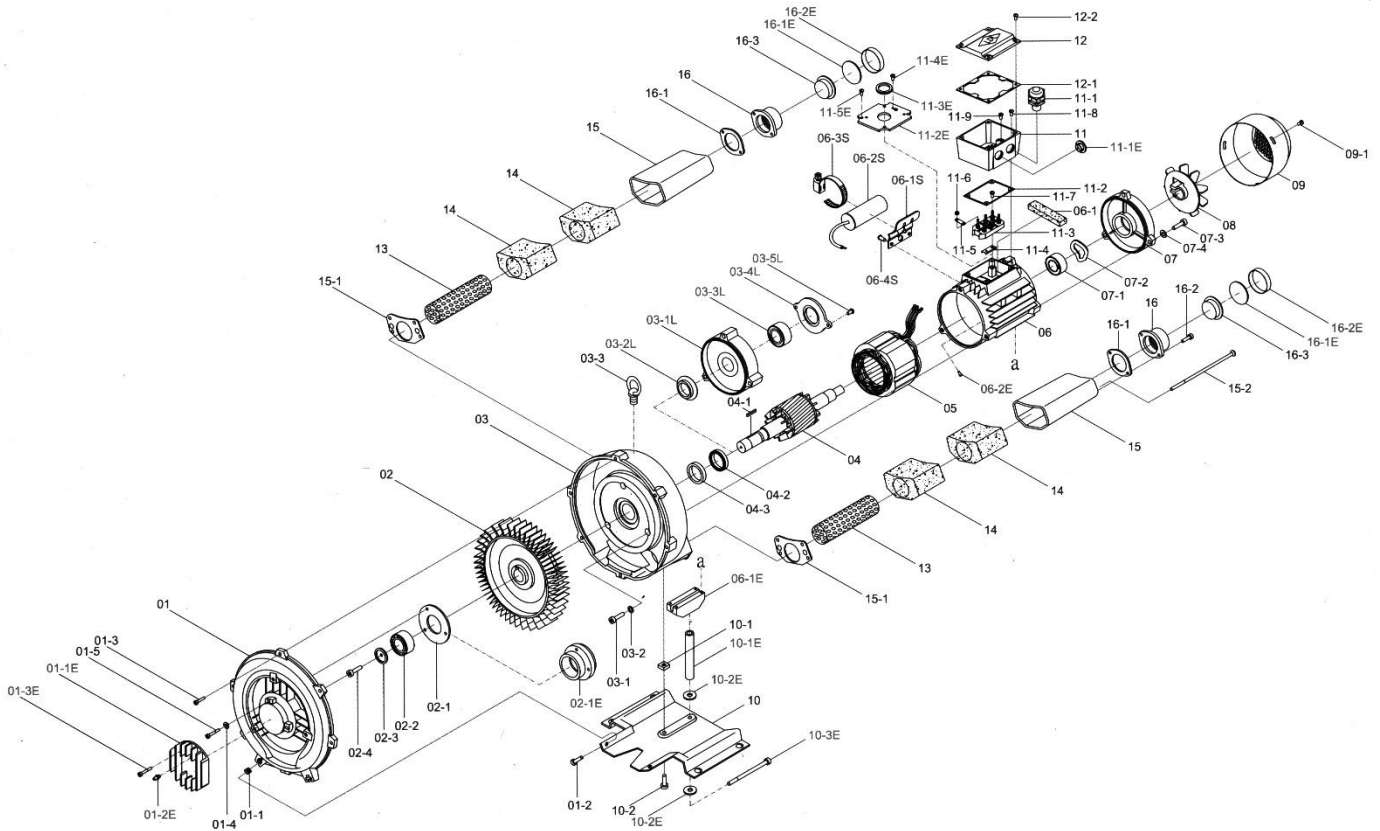

3.4

Parts list/drawing for double stage blowers (KB2308-KB8415)

ITEM	PART NAME	ITEM	PART NAME	ITEM	PART NAME	ITEM	PART NAME
01	Compressor Cover	06-1	Sponge Filler	11-4	Board Base	16	Inlet / Outlet Flange
01-1E	Front Bearing Cover	06-2	Middle Motor Cover	11-5	Wire Connection	16-1	Inlet (Outlet) Gasket
01-2E	Nipple	06-1S	Capacitor Bracket	11-6	Nut	16-3	Inlet (Outlet) Plug
02	Impeller	06-2S	Capacitor	11-1E	Plug	16-1E	Inlet (Outlet) Plate
02-1	Inner Bearing Cover	06-3S	Steel Clip	11-2E	Steel Plate	16-2E	Inlet (Outlet) Cover
02-2	Front Bearing	07	Motor Cover	11-3E	Rubber Ring	17	Middle Cover
02-3	Disc	07-1	Rear Bearing	12	Terminal Box Cover	18	Middle Housing
02-1E	Bearing Socket	07-2	Wave Washer	12-1	Rubber Gasket (Upper)	18-1	Impeller Fixing Set
03	Compressor Housing	08	Fan	13	Silencer Mesh	19	Protection Cowl
03-3	Bronze Ring	09	Fan Cover	14	Silencer Foam	19-1	Buckle (Up)
04	Rotor	10	Base	15	Silencer Casing	19-2	Buckle (Down)
04-1	Key	10-1E	Support	15-1	Silencer Gasket	20-1E	90° Extended Pipe
04-2	Oil Seal	11	Terminal Box	15-3	Silencer Socket	20-2E	End Cover
04-3	Felt Ring	11-1	Cable Gland	15-4	Silencer Socket Gasket	Parts not listed are standard ones, e.g. nut,screw,washer...	
05	Stator & Coil	11-2	Rubber Gasket (Under)	15-1E	Outlet Cover		
06	Motor Housing	11-3	Terminal Board	15-2E	Extended Pipe		

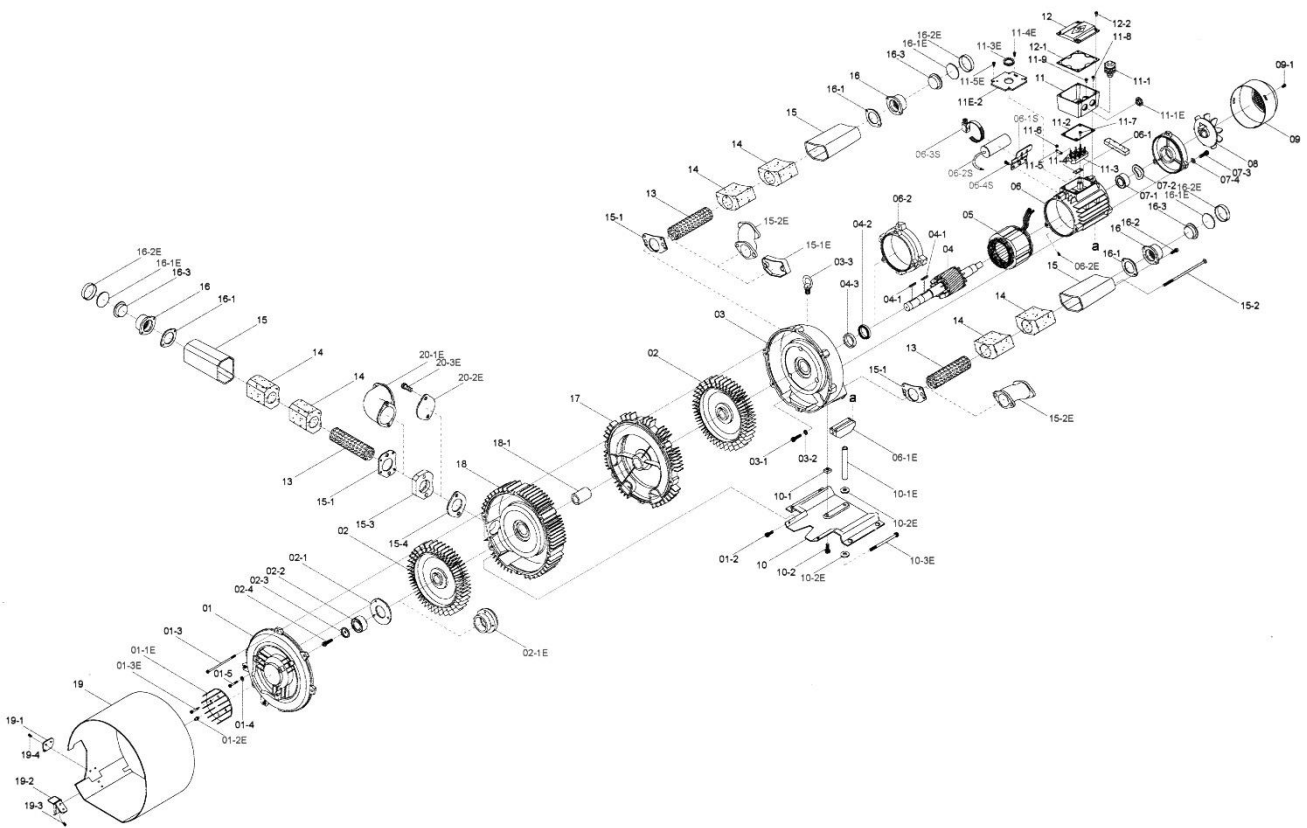

3.5

Bearings

<i>Type no.</i>	<i>Front bearing</i>	<i>Rear bearing</i>
<i>KB-129 KB-129L</i>	<i>6202ZZCM</i>	<i>6201ZZCM</i>
<i>KB-229 KB-229L</i>	<i>6203ZZCM</i>	<i>6202ZZCM</i>
<i>KB-329 KB-329L KB-339</i>	<i>6204ZZCM</i>	<i>6203ZZCM</i>
<i>KB-429 KB-429L</i>	<i>6205ZZCM</i>	<i>6204ZZCM</i>
<i>KB-529 KB-529L KB-629 KB-629L Kb-639</i>	<i>6206ZZCM</i>	<i>6304ZZCM</i>
<i>KB-729 KB-829</i>	<i>6207ZC3</i>	<i>6207ZZCM</i>
<i>KB-919 KB-929 KB-939</i>	<i>6308ZC3</i>	<i>6209ZZCM</i>
<i>KB-2308 KB-2309 KB-2315</i>	<i>6203ZZCM</i>	<i>6202ZZCM</i>
<i>KB-3319 KB-3326</i>	<i>6204ZC3</i>	<i>6204ZZCM</i>
<i>KB-4337 KB-4346</i>	<i>6205ZC3</i>	<i>6304ZZCM</i>
<i>KB-6346</i>	<i>6206ZC3</i>	<i>6304ZZCM</i>
<i>KB-6355 KB-6375 KB-6455 KB-6475</i>	<i>6206ZC3</i>	<i>6207ZZCM</i>
<i>KB-8310</i>	<i>6207ZC3</i>	<i>6207ZZCM</i>
<i>KB-8315 KB-8320</i>	<i>6207ZC3</i>	<i>6209ZZCM</i>
<i>KB-8410 KB-8415</i>	<i>6207ZC3</i>	<i>6207ZZCM</i>

3.6 Troubleshooting

Problem	Cause	Counter measures
Motor does not start, no rotor noise.	At least two power lines are interrupted.	Eliminate interruption by means of fuses, terminals or broken wire.
Motor does not start, humming noise.	Interruption in one power line.	Eliminate interruption by means of fuses, terminals or broken wire.
	Impeller jammed.	Open cover, remove foreign material, clean; if necessary check impeller gap adjustment and correct if necessary.
	Impeller defective.	Replace impeller.
	Motor bearings defective.	Replace bearings.
Motor protective circuit-breaker trips again after motor is switched on, power consumption is too high.	Short circuit in the winding	Arrange for winding to be inspected.
	Motor overloaded	Reduce operating pressure, clean filter, silencer, connecting pipes if necessary.
	Blower jammed	Open cover, remove foreign material, clean; if necessary check impeller gap adjustment and correct if necessary.
No vacuum or too weak vacuum is produced	Leak in the system	Make system air-tight
	Wrong direction of rotation	Change direction of rotation. (Changeover two motor wires.)
	Wrong frequency	Correct frequency
	Blower too small	Use larger blower; Fit new shaft seal; Pay attention to conversion of pressure values; Clean impeller, replace defective impeller with new one.
Blower not air-tight	Sealing disc defective	Inspect sealing disc.

3.7 EC Declaration of Conformity



EC Declaration of Conformity

BRD. KLEE A/S
Gadagervej 11
DK-2620 Albertslund
Tlf. +45 43868333
Fax +45 43868388
e-mail: klee@klee.dk
www.klee.dk

The supplier : Brd. Klee A/S
Gadagervej 11, 2620 Albertslund, Denmark

CVR 46874412
Danske Bank A/S
Reg. nr. 9541
Konto nr. 0003069400
IBAN nr.
DK5730000003069400
SWIFT DABADKKK

declares that the product described : Side channel blower

Model:

Single stage: KB129, KB129-1, KB129L, KB129L-1, KB229, KB229-1, KB229L, KB229L-1, KB329, KB329-1, KB329L, KB329L-1, KB339, KB429, KB429-1, KB429L, KB429L-1, KB529, KB529L, KB629, KB629L, KB729, KB829, KB929, KB929L, KB939

Double stage: KB2308, KB3319, KB3326, KB4337, KB4346, KB6346, KB6355, KB6375, KB8310, KB8315, KB8320, KB8410, KB8415

conforms to the following Directives:

2006/42/EC, 2006/95/EC, 2004/108/EC

uses the following standards:

EN 60034-1:2004, EN ISO12100-1, EN ISO12100-2, EN 60204-1, EN 349,

EN ISO 14121-1:2007, EN ISO 13850:2008, EN ISO 13857:2008,

complies with the relevant essential health and safety requirements of the Machinery Directive 2006/42/EC, the relevant essential requirements of Low Voltage Directive 2006/95/EC, and is in conformity with the protection requirements of Council Directive 2006/108/EC.

General Manager / Lars Ejnar Jensen

Copenhagen, 10/5-2009
Brd. Klee A/S.