

HOUSE OF
DURATECH
innovative pool products

Manual

PL-REM-60

welldana[®]
● ● ●



12-09-22

LINK Driver

Table of contents

Technical specifications	Page 3
Box contents	Page 4
Installation instructions	Page 5
Pairing Handheld Transmitter & controller	Page 6
Handheld transmitter functions	Page 7
Replacing transmitter battery	Page 7
Troubleshooting	Page 8

DURALINK

Technical specifications

Electrical specifications

Nominal Input voltage	230 VAC 50 Hz
Output voltage on Lamp Output	12 VAC
Max output current on Lamp Output	5A
Transformer VA rating	60VA
Frequency band transmitter	868 MHz
IEC Protection Class	Class II <input type="checkbox"/>

General specifications Controller

Ambient air temperature	0°C ... +40°C
Humidity	10% ... 90% RH non condensing
Dimensions	150x157x51 mm
Weight	1,3 kg
Ingress Protection Rate	IP54

Box contents

1. PL-REM-60 controller
2. Handheld transmitter
3. Spare battery
4. Screws (4x) & wall plugs (4x)
5. Owner's Manual

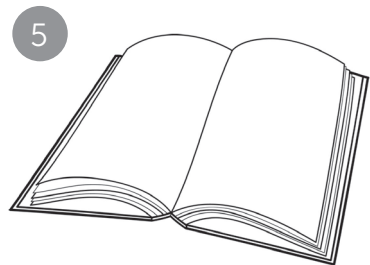
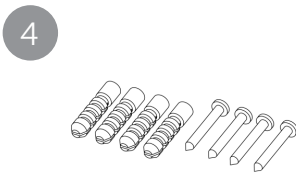
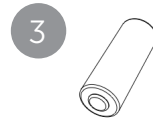
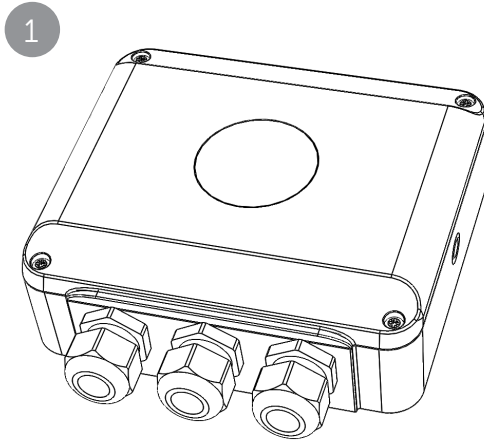

Installation instructions

- Connect a 230VAC power source to the “220-240VAC INPUT” terminal.
- Connect the swimming pool lights to the “Lamp 12VAC output” terminal

 Make sure the total load of pool lights does not exceed 60Watt

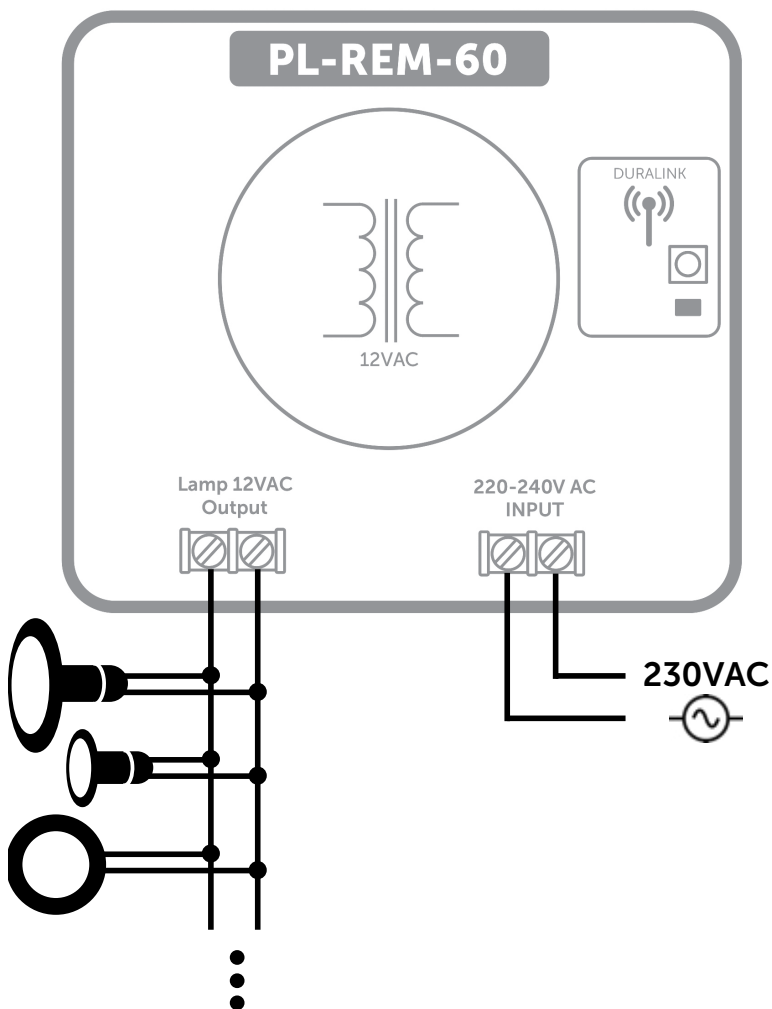

Pairing handheld transmitter & controller

The handheld transmitter is already paired in the factory and ready to use. The PL-REM-60 can pair with up to 6 handheld transmitters. In case a problem arises, the pairing process can be done manually:

Manual Pairing process:

Make sure the PL-REM-60 is connected to a power source.

1. Press the pairing button on the small circuit board, inside the controller for at least 5 seconds.
 - > The LED will start to blink fast
2. Within 25 seconds, press any button on the handheld transmitter.
 - > If the transmitter is paired correctly, the LED will flash slowly for 5 times
 - > If the PL-REM-60 pairing memory is full, the LED will flash 15 times. This means 6 handheld devices have already been paired.

To unpair all handheld transmitters with the controller: Push the pairing button for at least 5 seconds, then do nothing for at least 25 seconds.

--> The pair memory will be erased - the green LED will flash 5x on/off.

⚠ *If no transmitters are paired, the PL-REM-200 will accept messages from any transmitter!*

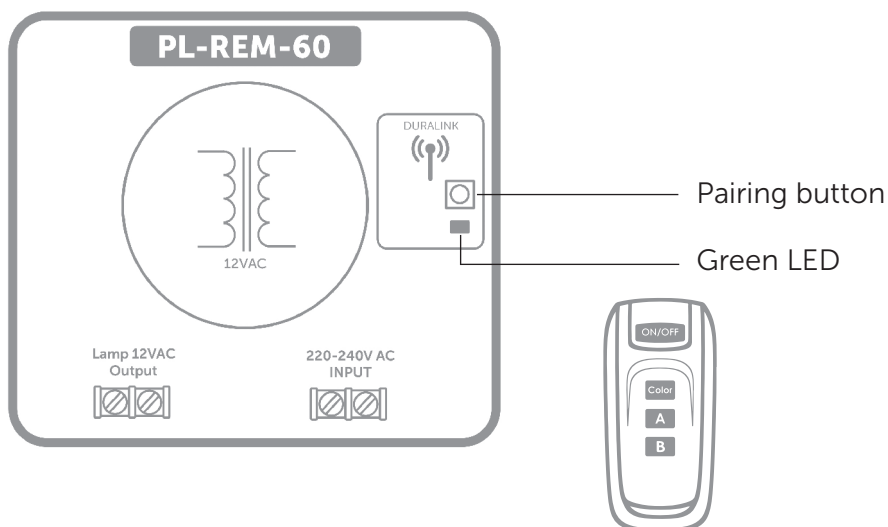

Handheld transmitter functions

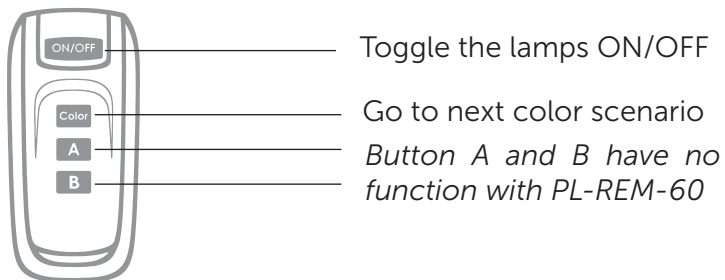

Replacing transmitter battery

- Remove the philips head screw and open the transmitter
- Replace the battery, respecting the polarity

Battery type: A23 12V

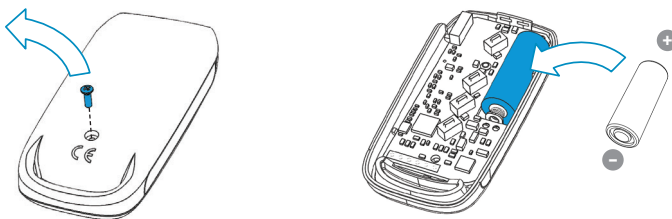

Troubleshooting

PROBLEM

The controller doesn't react to transmitter commands

SOLUTION

- Check the battery of the handheld transmitter
- The transmitter is not paired correctly with the controller. Repeat the pairing process
- Reduce the distance between handheld transmitter and PL-REM-60 and/or eliminate obstacles

The pool lights don't work

- Check the red status LED
- Check if there is 12VAC output at the terminals of the controller

Declaration of Conformity

Declarations of conformity covering this product are available for download from the House of Duratech website: www.duratech.be

Notes

HOUSE OF
DURATECH
innovative pool products

DURAVISION

Pool Light products

- VISION Moonlight
- VISION Spectra
- VISION Adagio Pro
- VISION Pro
- VISION Wall Conduits
- VISION Faces Plates
- VISION Specials

DURAEAT

Heat Pump products

- HEAT Hot Splash
- HEAT Sun Spring
- HEAT Dura V
- HEAT Dura Vi
- HEAT Dura -i
- HEAT Dura Pro
- HEAT Accessories

DURAFLOW

Pool Flow products

- FLOW Inverter

DURACOVER

Cover System products

- COVER Tube
- COVER Motor
- COVER Wall Duct
- COVER Cable Duct
- COVER Hanging System

DURALINK

Control products

- LINK Driver
- LINK Touch
- LINK Controller
- LINK Cover
- LINK Master
- LINK Accessoires



Contact details

Propulsion Systems bv
Dooren 72
1785 Merchtem, Belgium

Tel +32 2 461 02 53

www.duratech.be
info@propulsionsystems.be



DURALINK

402-0081-2



We reserve the rights to change all or part of the contents of this document without prior notice