

Inverter Salt Chlorinator

Operating Instructions



Mr. Pure

INDEX

1 Warnings.....	1
2 Product Introduction	2
2.1 Product Specification.....	2
2.2 Electronic Connections	3
3 Pool Water Preparation	5
3.1 Adding Salt	5
3.2 Chemical Water Balance	5
4 Control Unit Operation	6
4.1 General Screen View	6
4.2 Chlorine Production Mode Introduction.....	8
4.3 Basic Commands and Functions.....	8
4.4 Combinations and Operation	16
5 Salt Replenishment	17
6 Maintenance	18
6.1 Cleaning the Electrodes	18
6.2 Maintenance of the ORP Probe (Only Premium)	18
6.3 Maintenance of the pH Probe (Premium/Medium)	19
7 Winterizing.....	19
8 Wi-Fi Instruction	20
8.1 Start-Up	20
8.2 OTA Upgrade	23
8.3 Device Sharing	23
9 Error Code and Solution.....	24

1 Warnings



WARNING: General Information

1. Carefully read all the instructions in this manual and on the device. Failure to read and comply with the instructions can cause injury. This document must be given to the pool owner / custodian, who should keep it in a safe place for reference.
2. Chemicals can cause internal and external burns. To avoid death, serious injury and/or damage to equipment, always wear personal protective equipment (gloves, goggles, mask, etc.) when servicing or maintaining this device. This device must be installed in an adequately ventilated place.
3. The appliance is not to be used by persons (including children) with reduced physical, sensory, or mental capabilities, or lack of experience and knowledge, unless they have been given supervision or instruction.
4. Children must not play with this device. User maintenance and cleaning must not be carried out by unsupervised children.
5. Use only original Aquark parts.
6. Instructions are also available on <https://www.aquark.com/mr-pure-full-inverter-salt-chlorinator>



WARNING: Electrical Hazard

1. This equipment is intended to be used on swimming pools only.
2. Disconnect the equipment from the mains supply before any intervention or maintenance.
3. All electrical installations must be carried out by a qualified and approved electrician in accordance with the standards currently in force in the country of installation.
4. Check that the device is plugged into a power outlet that is protected against short-circuits. The device must also be powered via an isolating transformer or a residual current device (RCD) with a nominal operating residual current not exceeding 30 mA.
5. Check that the supply voltage required by the product corresponds to the voltage of the distribution network and that the power supply cables are suitable for the product's power demand.
6. To reduce the risk of electric shock, do not use an extension cable to connect the device to the mains. Connect directly to a wall socket.
7. This device must not be used if the power cord is damaged. An electric shock could result. A damaged power cord must be replaced by after-sales service or similarly qualified persons to avoid danger.

2 Product Introduction

2.1 Product Specification

Model	MPS14	MPS22	MPS30	MPS34
Max. Chlorine Production (g/h) (Salinity: 3000 PPM)	14	22	30	34
Pool Volume (m ³)	20-50	35-90	40-110	50-130
Recommended Salinity	1 – 5 (recommended 3g/L)			
Power Supply	AC 100~240V 50/60Hz			
Max. Output Voltage	DC 12V			
Max Input Power	80W	115W	135W	140W
Advised water flux	5 m ³ /h~20 m ³ /h			
Operating Water Temperature	10°C~40°C			
Ambient Temperature	-5°C~42°C			
Pressure for Electrolytic Cell	3.0 Bar			
IP Rating	IPX4			
Cell Lifetime	Up to 12000H			

2.2 Electronic Connections

2.2.1 Control Unit with In-Built pH Regulator



No.	Port Name	Photo	Description	
1	ORP		BNC Connector for ORP sensor	
2	pH		BNC Connector for pH sensor	
3	TEMP		BNC Connector for temperature sensor (Integrated with the pH sensor)	
4	485 COM		1	485 - GND
			3	485 - B
			4	485 - A
5	Flow Switch		Connector for flow switch	
6	Power Output		Terminal for cell power	
7	In-built pH Regulator		Left	Acid inlet
			Right	Acid outlet
8	Power Input		AC power connector (110/220V, 50/60Hz)	
9	AUX		Reserved power connector	

2.2.2 Control Unit with External pH Regulator

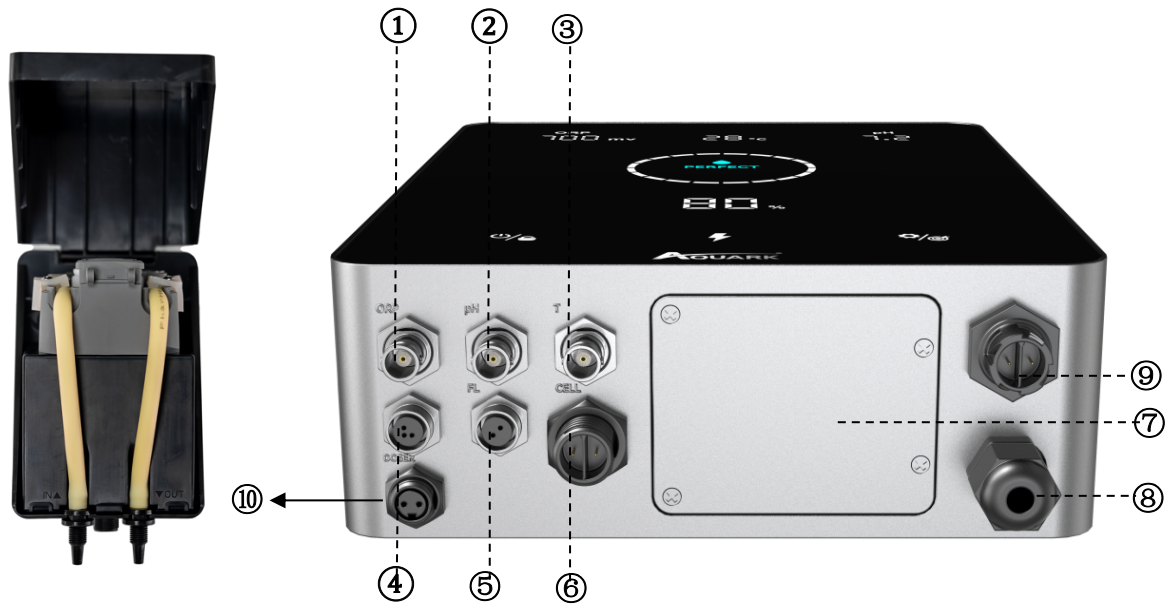

No.	Port Name	Photo	Description	
1	ORP		BNC Connector for ORP sensor	
2	pH		BNC Connector for pH sensor	
3	TEMP		BNC Connector for temperature sensor (Integrated with the pH sensor)	
4	485 COM		1	485 - GND
			3	485 - B
			4	485 - A
5	Flow Switch		Connector for flow switch	
6	Power Output		Terminal for cell power	
7	Decorative Panel		External pH regulator decorative panel	
8	Power Input		AC power connector (110/220V, 50/60Hz)	
9	AUX		Reserved power connector	
10	Doser		Connector for external pH regulator	

3 Pool Water Preparation

To prepare the pool water to enable the chlorinator, its chemical composition must be balanced and salt added. Certain adjustments to the chemical balance of the pool can take several hours.

The procedure **MUST** therefore be started well **BEFORE** the chlorinator is turned on.

3.1 Adding Salt

Add the salt 24 hours before turning on the chlorinator with the pump working. Ensure that the recommended amount of salt is not exceeded.

Measure the salt content 6 to 8 hours after the amount has been added to the swimming pool.

NOTE:

- If the water in the pool is not fresh and/or if it is liable to contain dissolved metals, use a metal remover, according to the manufacturer's instructions.
- If your water has previously been treated with a product other than chlorine (bromine, hydrogen peroxide, PHMB, etc.), neutralize this product or replace all the water in the pool.
- If using mineral salt (Magnesium chloride and / or Potassium chloride) add approx. 1.4times the amount of normal salt. (Optimum mineral salt level 4200ppm).

3.2 Chemical Water Balance

The water must be balanced manually **BEFORE** the device is started up.

The following table summarizes the concentrations recommended. Your water should be checked regularly to maintain these concentrations and minimize surface corrosion or deterioration.

CHEMISTRY	Recommended CONCENTRATIONS
Salt	Salt 3 g/l
Salt (Low salt)	Salt (Low salt) 1 g/l
Free chlorine	Free chlorine 1.0 to 3.0 ppm
pH	pH 7.2 to 7.6
Cyanuric acid (Stabilizer)	20 to 30 ppm max, 0 ppm in indoor pool (Add stabilizer only if necessary)
Total alkalinity	80 to 120 ppm
Water hardness	200 to 300 ppm
Metals	0 ppm
Algaecide	Use of algaecide is an option, but must be copper free

4 Control Unit Operation

4.1 General Screen View

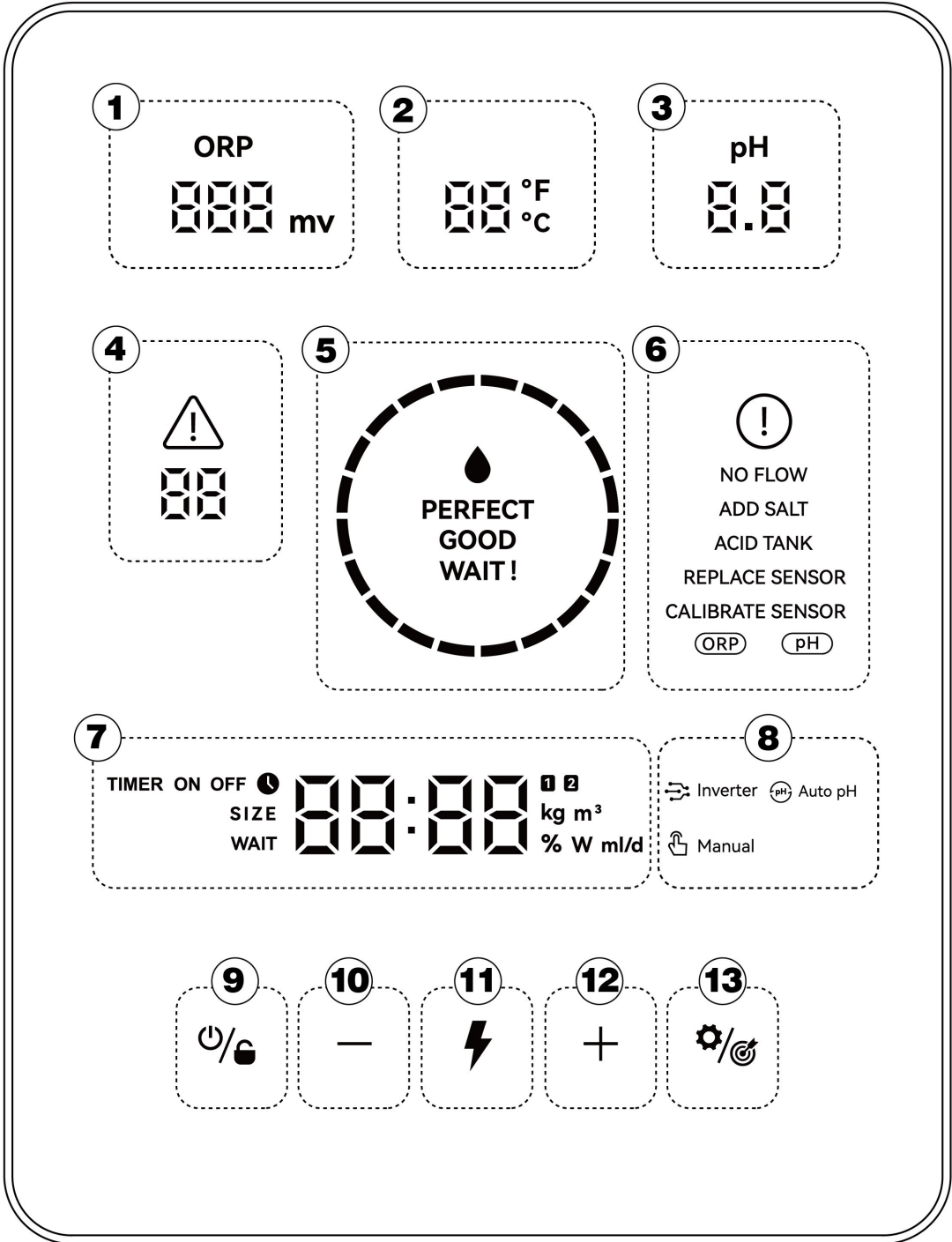

Marked Area	Description	Icon
①	Real-time ORP value *display "---" when the value exceeds 990mV * When ORP < 600, the ORP icon and number flash.	ORP 888 mv
②	Real-time water temperature (°C/°F)	88 °F 88 °C
③	Real-time pH * When pH < 6.5 or pH > 8, the pH icon and number flash.	pH 8.8
④	Error codes	! (warning triangle) 88
⑤	LED Indicator *Water quality/OTA updating progress/ Abnormal ORP or pH value (LED keep blinking) * Only available with ORP probe & pH/Temp probe	PERFECT GOOD WAIT!
⑥	Warnings	! (warning triangle) NO FLOW ADD SALT ACID TANK REPLACE SENSOR CALIBRATE SENSOR ORP pH
⑦	Main display area (pool volume, turbo mode countdown, salt adding amount, time, acid adding amount, real-time chlorine production)	TIMER ON OFF SIZE WAIT 88.88 kg m³ % W ml/d
⑧	Chlorine Production Mode: Inverter Mode	Inverter
	Chlorine Production Mode: Auto pH Mode	pH Auto pH
	Chlorine Production Mode: Manual Mode	Manual
⑨	Power/Lock Switch	Power/Lock icon
⑩	Tuning down	-
⑪	Turbo Mode Switch	Lightning bolt icon
⑫	Tuning up	+
⑬	Settings/Calibration	Settings/Calibration icon

4.2 Chlorine Production Mode Introduction

The chlorinator can be configured to 3 different types according to different chlorine production modes.

Configuration		Premium Model	Medium Model	Basic Model
Hardware Options		ORP+pH+Doser	pH+Doser	/
Selectable Chlorine Production Mode	Inverter Mode	√	-	-
	Auto pH Mode	-	√	-
	Manual Mode	√	√	√

The HOME screen of each chlorine production mode is shown as follows:

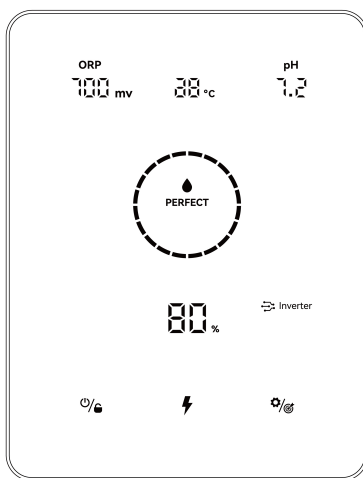

Inverter Mode

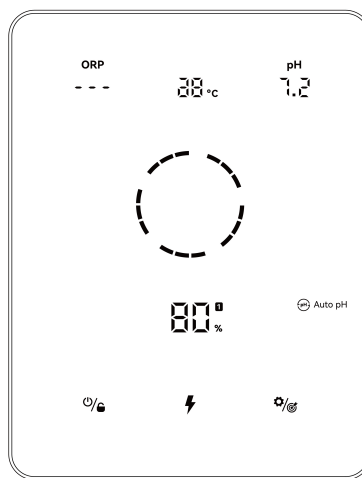

Auto pH Mode

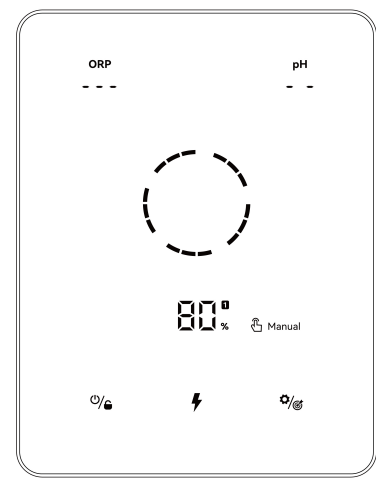

Manual Mode

The LOCK screen of each chlorine mode is shown as follows:

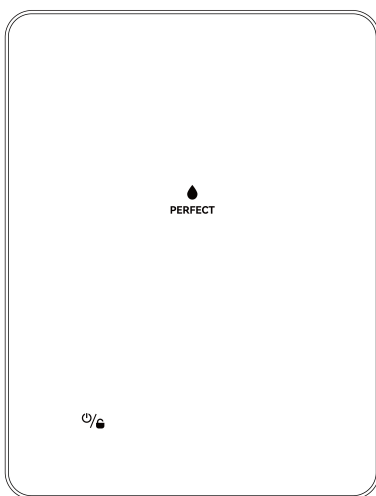

Inverter Mode

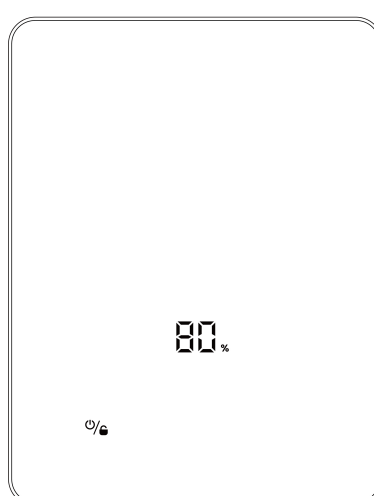

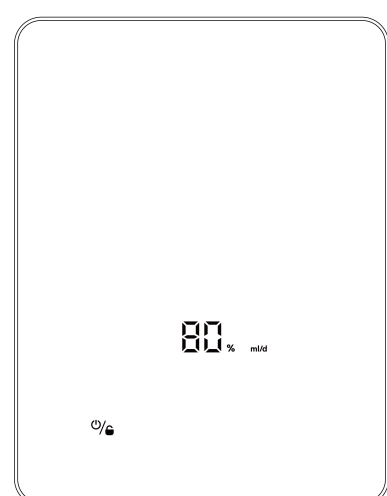

Auto pH Mode



Manual Mode

4.3 Basic Commands and Functions

Command Keys	Function
	<ol style="list-style-type: none"> Power ON: Hold for 3 seconds initially. Power OFF: Tap on home screen. Lock/Unlock: Hold for 3 seconds. <p>Note: The auto lock function will be activated after 2 minutes without any operation.</p>
	<ol style="list-style-type: none"> Activate TURBO mode: Tap. Exit TURBO mode: Hold for 3 seconds
	<ol style="list-style-type: none"> Start setting process/ Start calibration process/ Go to next step: Tap. Back to home screen: Hold for 3 seconds.

4.3.1 Start Up/ First-time Initialization

When switching on the control unit for the first time or right after restoring factory settings, the pad screen operation follows the initialization process.

Premium Configuration:

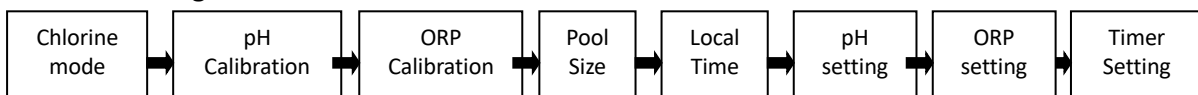



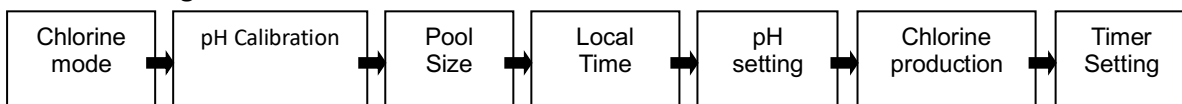

Medium configuration:

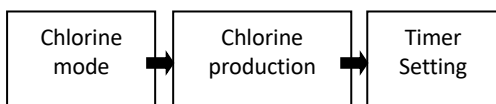

Basic Configuration:



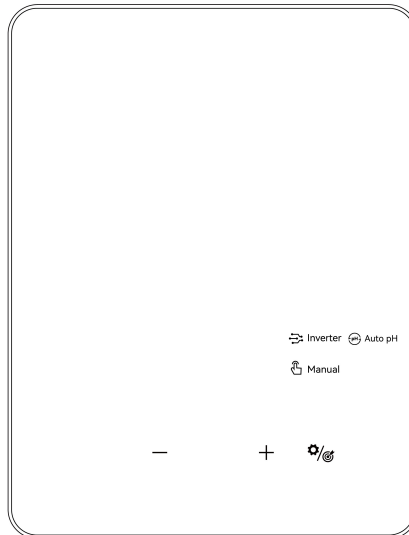

① Chlorine Production Mode Selection

- The default mode  Inverter /  Auto pH /  Manual starts to blink;
- Tap + or - to select chlorine production modes;
- Tap  to confirm your selection, and go to next step.



② pH 7.0 & pH 10.0 Calibration (Premium/Medium)

- When the digit display “pH 7.0” and the circle indicator is flashing on the pad screen, place pH probe into the PH7.0 buffer solution. Make sure the head of the probe is totally immersed.
- Calibration is completed when the beeper sounds and the circle vanish.
- Tap  to the next step, pH 10.0 calibration. (Remember to clean the pH probe before pH10.0 calibration).
- The entire process of pH 10.0 calibration is the same with pH 7.0 calibration.
- Tap  to next step.

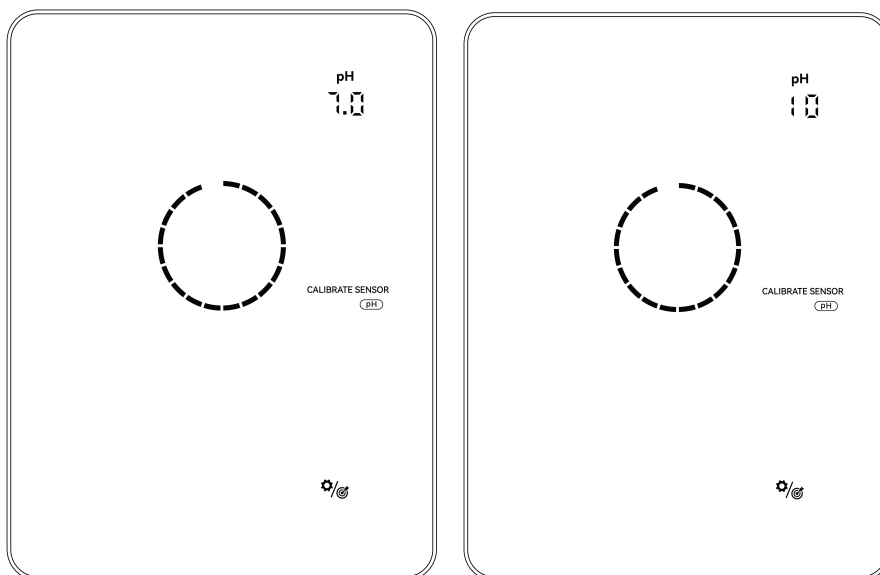

NOTE:

- This step can also be skipped by tapping the setting button .

- If the pH probe stays unsoaked by the buffer solution for 30 seconds or is soaked in the wrong solution, the circle will keep flashing until the probe is correctly initiated.
- Before calibrating or replacing the probe, isolate the electrolytic cell by closing the IN/OUT flow valves.

③ ORP Calibration (Only Premium)

- When the default digit display “ORP 468 mV” and the circle indicator is flashing on the screen.
- Place ORP probe into 468mV buffer solution, make sure the head of the probe is totally immersed.
- Calibration is completed when the beeper sounds and the circle vanishes.
- Tap  to next step.

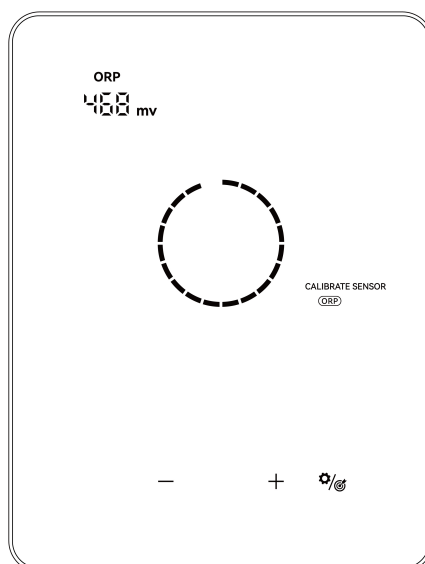

NOTE:



- ORP calibration values range from 200-600, step size is 1, hold the button can accelerate the tuning speed.
- This step can also be skipped by tapping .
- If the ORP probe stays unsoaked by the buffer solution for 30 seconds or is soaked in the wrong solution, the circle indicator will keep flashing until the probe is handled properly.

④ Pool Volume Setting

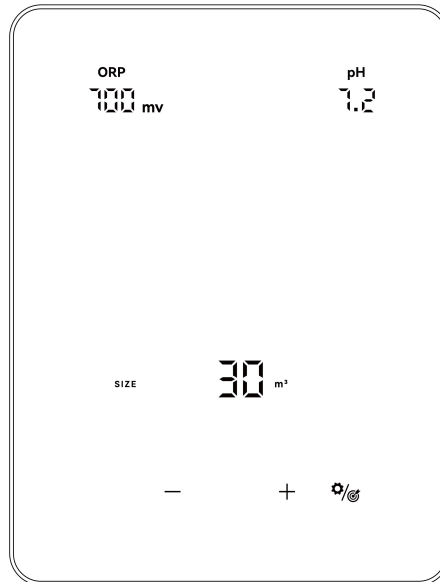
- The default digit display on the pad screen is “SIZE 30 m³” as follows.
- When the number “30” is blinking, it can be tuned from 5 to 150 m³, in increments of 5, by tapping + or -. Hold the button can accelerate the tuning speed.
- Tap  to next step.



⑤ Local Time Setting

- When the local time is blinking, set hours of the local time by tapping + and -, save the parameter by tapping , then set and save minutes in the same way.
- Tap  to next step.

⑥ pH Setpoint Setting (Premium/Medium)

- The default digit display on the pad screen is “7.2” .
- When the number “7.2” is blinking, it can be tuned from 6.5 to 8.5, in increments of 0.1, by tapping + or -. Hold the button can accelerate the tuning speed.
- Tap  to next step.

⑦ ORP Setpoint Setting (Only Premium)

- The default digit display on the pad screen is “700mV” .
- When the number “700” is blinking, it can be tuned from 200 to 990 mV, in increments of 1, by tapping + or -. Hold the button can accelerate the tuning speed.
- Tap  to next step.



⑧ Chlorine Production (Auto pH Mode / Manual Mode)

- The default digit display on the pad screen is “100%”.
- When the number “100” is blinking, it can be tuned from 100 to 0, in increments of 5, by tapping $+$ or $-$. Hold the button can accelerate the tuning speed.
- Tap  to next step.



⑨ pH Dosing Volume Setting (Only Manual Mode)

- The default digit display on the pad screen is “50 mL/day”.
- When the number “50” is blinking, it can be tuned from 0 to 9990, in increments of 10, by tapping $+$ or $-$. Hold the button can accelerate the tuning speed.
- Tap  to next step.

⑩ Timers Setting

- When **TIMER ON** and **1** lights up, set hours of the first timer by tapping $+$ and $-$, save the parameter by tapping , then set and save minutes in the same way.
- When **TIMER ON** setting is finished, **TIMER OFF** lights up, set the end time of the first timer in the same way.
- When **1** vanishes and **2** lights up, set the start and end time of the second timer, if required in the same manner.
- Tap  to Confirm Timers setting and return to home screen.

4.3.2 TURBO Performance

- ① Switch ON: Tap  to enter turbo mode, the device will run at 130% power for 24 hours regardless of the ORP readings and/or setpoint values. The real-time production and turbo countdown will be displayed alternating every 10 seconds.
- ② Switch OFF: Hold  for 3 seconds.

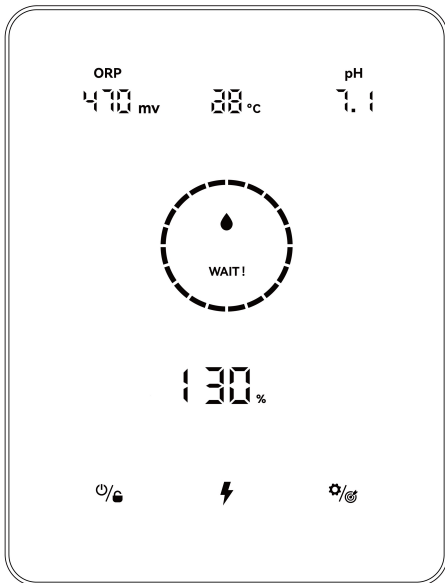

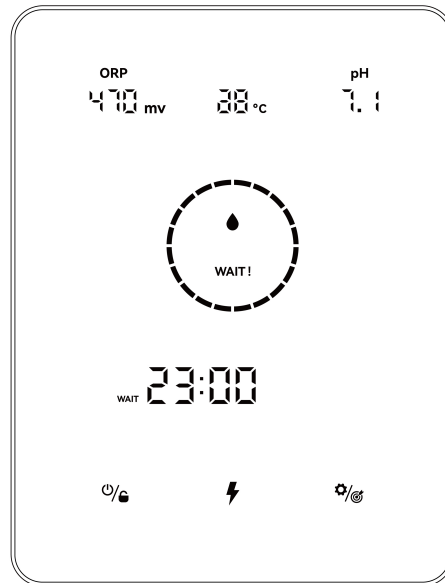

Operating Speed Display



Countdown Display

NOTE:

- TURBO mode is suggested to be activated when chlorine is urgently needed.
- TURBO mode cannot be activated When  or  lights up.
- If the chlorinator is powered off with TURBO mode turned on, the TURBO countdown refreshes when the chlorinator is turned on again.
- When the TURBO mode terminates or stops, production continues according to the preset settings.
- **NOTE:** If ORP value is lower than 500mV, the Turbo switch  will start flashing for 30 seconds. Then it stays lit when no remedial action is detected.

4.3.3 Settings

Tap Setting  to enter settings in accordance with following order:

- 1) pH Target Setting: range 6.5-8.5 (Inverter Mode / Auto pH Mode);
- 2) ORP Target Value setting: range 200-990mV (Inverter Mode)
 - Sug'td ORP Winter setting: ORP 650mV;
 - Sug'td ORP summer setting: ORP 700mV;
 - Summer (max load) setting: 750mV-800mV;
- 3) Chlorine Production: range 0-100% (Auto pH Mode / Manual Mode);
- 4) pH Dosing Volume Setting: range 0-9990 mL/day (Only Manual Mode)
 - Hydrochloric Acid: ≤12.5% concentration;

5) Timers setting: range 0:00-24:00 (24hr clock);

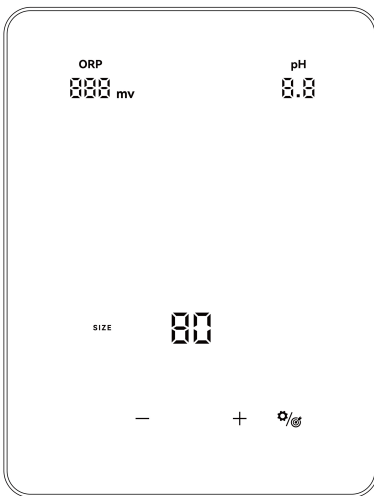

Settings (Inverter Mode)

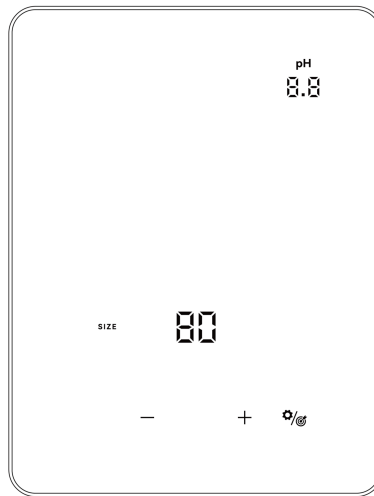

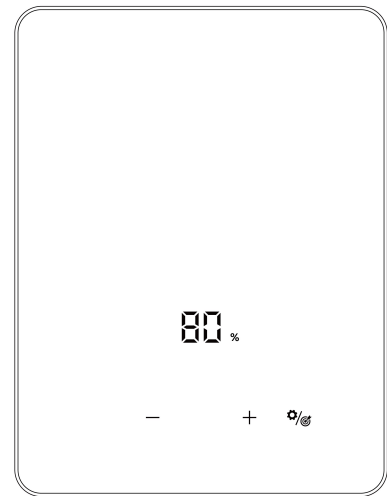

Settings (Auto pH Mode)





Settings (Manual Mode)

4.3.4 Calibration





Tap  and hold for 3 seconds to enter calibration mode in accordance with following order:

- 1) pH 7.0 and 10.0 Calibration (Inverter Mode / Auto pH Mode)
- 2) ORP Calibration (Inverter Mode)
- 3) Pool volume setting: range 5-150m³;
- 4) Local time setting: range 00:00-24:00 (24hr clock);
- 5) Tap  to return home screen;



NOTE:

- ① During the settings and calibration process, all values are set by tapping $+$ and $-$;
- ② Users can return to home screen at any point by holding  for 3 seconds, or skip any step by tapping .

4.4 Combinations and Operation

Combinations	Function
Hold  and  for 3 second	Enter chlorine mode selection screen
Tap  , then hold + and - for 3 second	Restore factory settings
Tap  , then hold  and + for 3 second	Enter network configuration screen

4.4.1 Chlorine Mode Selection

In home screen, hold  and  for 3 second, the chlorine mode selection screen shows as follows.

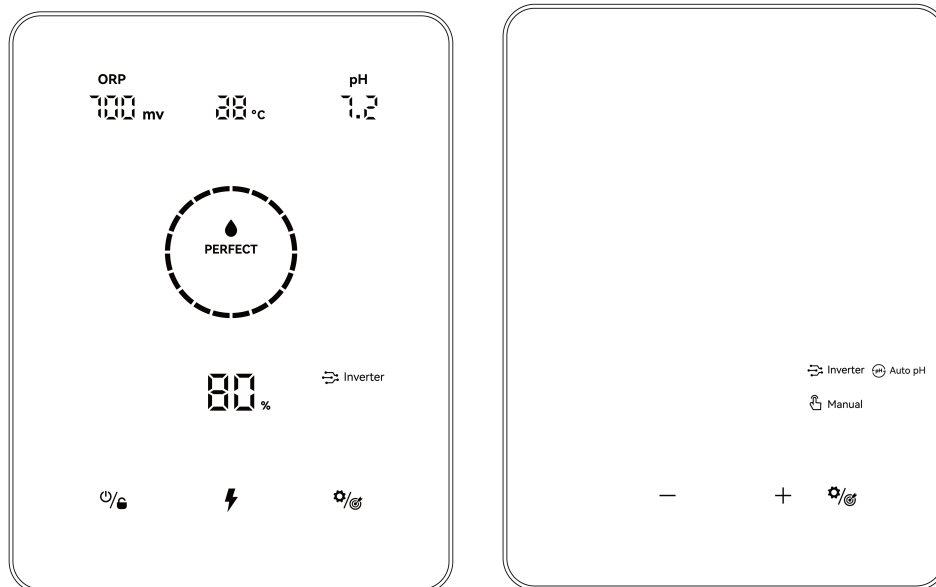

Tap + and - to choose chlorine production mode, according to different hardware options shown in 4.2.



The icon will start to flash when being selected. Tap  to confirm your selection, then the screen will return to home automatically.

4.4.2 Restore Factory Settings

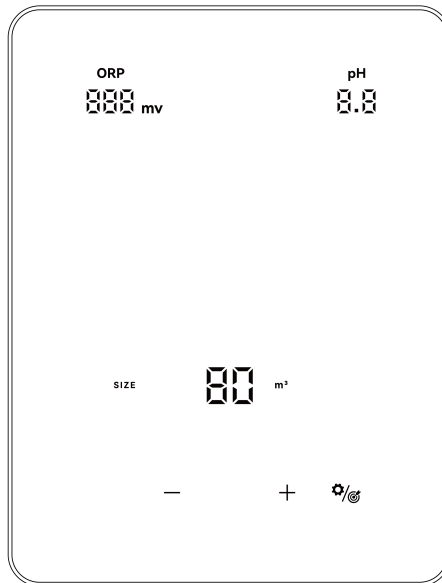
Tap  on home screen, then hold + and - simultaneously for 3 second, hearing the beeper, the chlorinator is restored to factory settings, and automatically will start initialization process as in 4.3.1:



4.4.3 Network Configuration

- ① Enter Network Configuration screen by tapping , then hold  and  simultaneously for 3 seconds, an intermittent buzz will be heard.
- ② During network configuration process, the chlorinator remains operating with the previous configuration.
- ③ The beeper stops when network configuration is complete.

5 Salt Replenishment

 **The chlorinator must remain OFF during this operation and until the additive is completely dissolved. Operating the chlorinator with non-dissolved salt could irreversibly damage the cell and the power supply, and lead to a void of the warranty.**

Calculate the volume of the swimming pool and add 3 to 5 Kg of salt per cubic meter. The suggested salinity is 3-5 g/L. Make sure the chlorinator is disconnected during the whole salt adding process, and turn on the filtration system for at least 24 hours, allowing the salt to dissolve completely.

 **For any new pool builds please wait for four weeks before adding salt into any recently cement coated pool or discuss this with your pool builder.**

The salt dissolving process can be accelerated using the pool cleaner. Check the salt concentration is between 3 and 5 kg/m³ using a kit from a specialized pool shop.

The salt concentration may reduce over time due to rain or other periodic freshwater contributions (topping up, backwashing, etc.). Whenever the salt concentration needs to be corrected, pour salt as close as possible to the return lines. Never pour salt in the skimmers or near the drain inlet.

6 Maintenance

6.1 Cleaning the Electrodes

The smart polarity inversion system is designed to prevent the electrode plates from corrosion and scaling (Default setting = 4 hours). However, periodic cleaning may be required when the water hardness is too high.

The cleaning process is listed as follows:

- ① Turn off the chlorinator and the filtering, close the isolation valves, and ensure power is disconnected at the isolating switch.
- ② Place the cell backwards and fill it with a cleaning solution so that the electrode plates are immersed.

Do not allow the cell cap assembly to be immersed.
- ③ Leave the cleaning solution to dissolve the scale deposit for about 15 minutes. Dispose of the cleaning solution at an approved waste recycling site, never pour into the rainwater drainage system or into the sewers.
- ④ Rinse the electrode using clean water and put it back on the cell fixture collar (there is an alignment mark).
- ⑤ Open the isolation valves and restart the filtering and chlorinator.
- ⑥ If you do not use a commercially available cleaning solution, you can manufacture it yourself by carefully mixing 1 volume of hydrochloric acid with 9 volumes of water (Warning: always pour the acid into the water and not the opposite and wear suitable protective equipment!).
- ⑦ Make sure that the setting of the polarity inversion cycles is adapted to the pool water hardness.

6.2 Maintenance of the ORP Probe (Only Premium)

6.2.1 Cleaning the Probe

Under any circumstance, every 6 monthly cleaning is always advisable. Generally, impurities and grease caught on electrodes may also result in measurement errors.

The cleaning steps are as follows:

- ① Turn off the chlorinator, close flow isolating valve, and unscrew the ORP probe from the holder.
- ② Thoroughly clean the probe in pure, preferably distilled water. Carefully shake the probe to remove the water. Use a cotton or a paper napkin if necessary.
- ③ Turn on the control unit, Insert the probe into standard calibration solution (default 468mV) and complete the calibration process.

6.2.2 Storage

In case of pools being shut down during the winter season, take the probe out of the cell and store it at temperature from +5 to +30 °C in the probe storage cap filled with a storage solution.

Other storage methods are not recommended.

NOTE: Never leave the probe in the open air. If the probe has been dry for a time, it can be regenerated using the standard calibration solution.

6.3 Maintenance of the pH Probe (Premium/Medium)

6.3.1 Maintenance

It is recommended to clean and check the probe every 6 months. Generally, impurities and grease caught on electrodes may also result in measurement errors.

The cleaning steps are as follows:

- ① Stir the probe in a glass of water in which a spoonful of detergent has been dissolved.
- ② Wash it under the tap and leave it for a few hours in a glass of water in which 1 cm³ of hydrochloric acid has been added.
- ③ Thoroughly clean the probe in pure, shake the probe to remove the water. Use a cotton or a paper napkin if necessary.
- ④ Recalibrate the probe again.

6.3.2 Storage

In case of pools being shut down during the winter season, take the probe out of the cell and store it at temperature from +5 to +30 °C in the probe storage bin filled with a storage solution.

Other storage methods are not recommended.

NOTE:

- If well maintained, a probe can last for two or three years. When the probe is exposed in air, the original cap should be placed, or it should be submerged in a glass of water.
- If a probe has been left to dry, it can be regenerated by leaving it for 12 hours in a glass of water, preferably adding a few drops of hydrochloric acid.

7 Winterizing

The chlorinator has a protective system to limit chlorine production under poor operating conditions such as cold water (winter) or a lack of salt.

Active winterizing = filtering operational in winter:

- Above 10°C: Chlorinator running in preset mode.
- Below 10°C: Chlorinator running, capped at 30%.
- Below 5°C: Electrolytic cell off.

Passive winterizing = lower water level and drained piping: leave the electrode dry in its cell with its isolation valves- open.

8 Wi-Fi Instruction

8.1 Start-Up



8.1.1 Download App on Smartphone

“InverGo” app is available on App Store and Google Play.

8.1.2 Networking Configuration

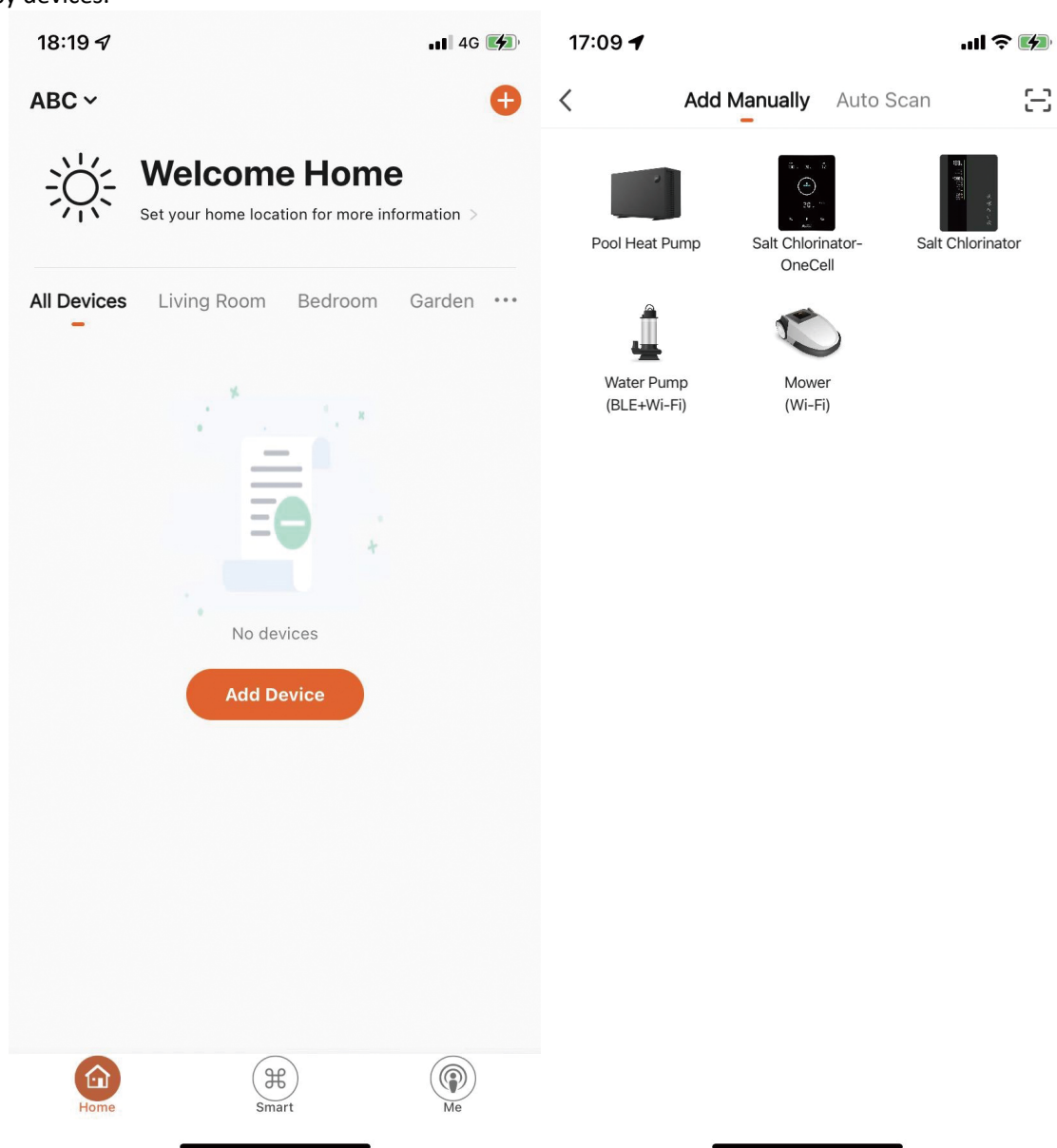
Turn on your location services, Wi-Fi and Bluetooth, enter the “InverGo” App, tap the "+" icon in the top right corner of the home page, and then Tap on "Add Device", then tap “Auto Scan” to start searching for nearby devices.



When Control Panel is on home screen, tap  to enter settings, hold  and  for 1.5 seconds, when an intermittent beep occurs, and enters network connection mode. When your phone finds the Control Unit, it will be displayed on your phone. Tap "Next", input the hotspot password and tap "Next". Then the device will be automatically installed in the App.

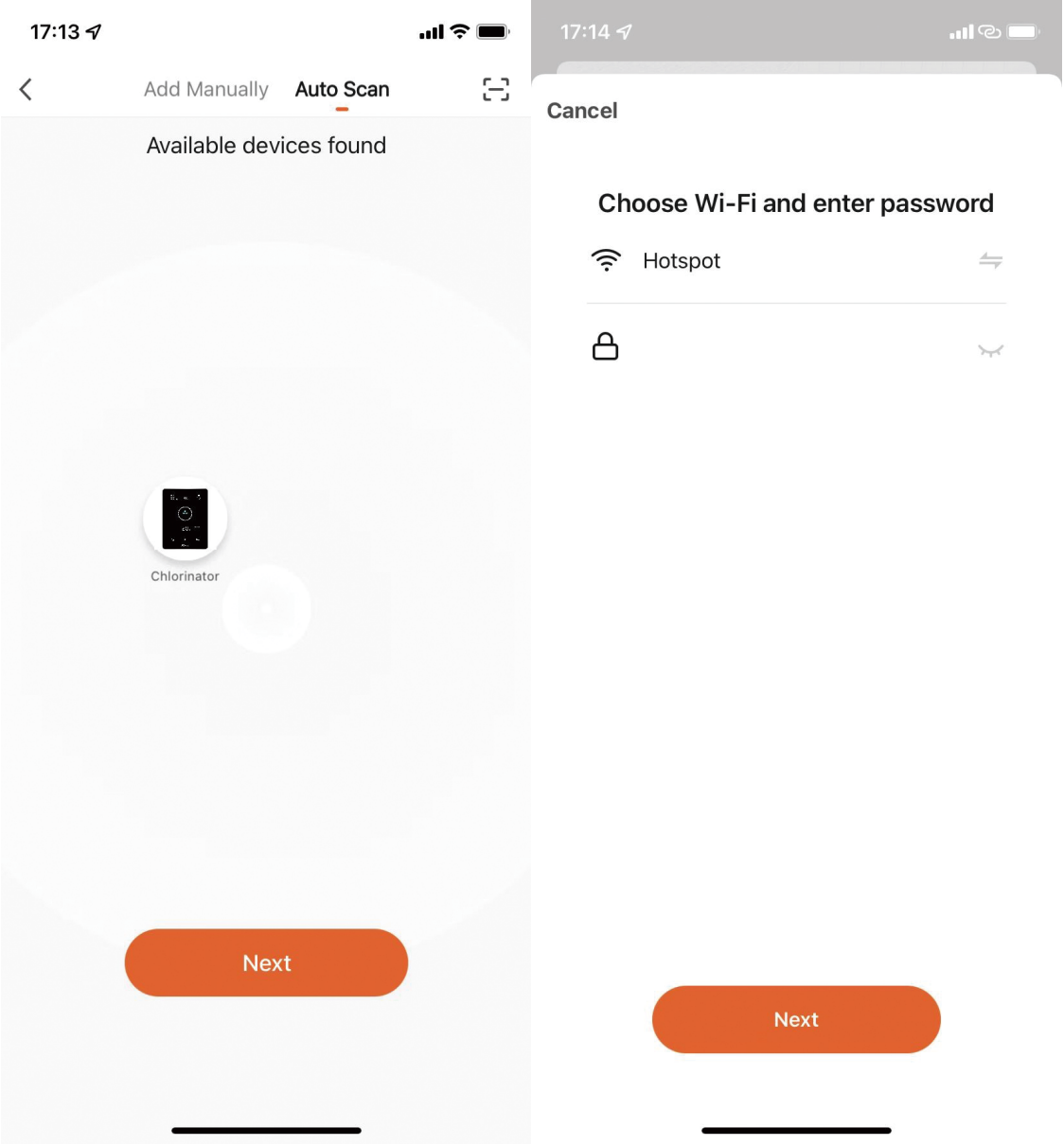

When installation is finished, the device will beeper 3 times and on the App, it will be shown as added.

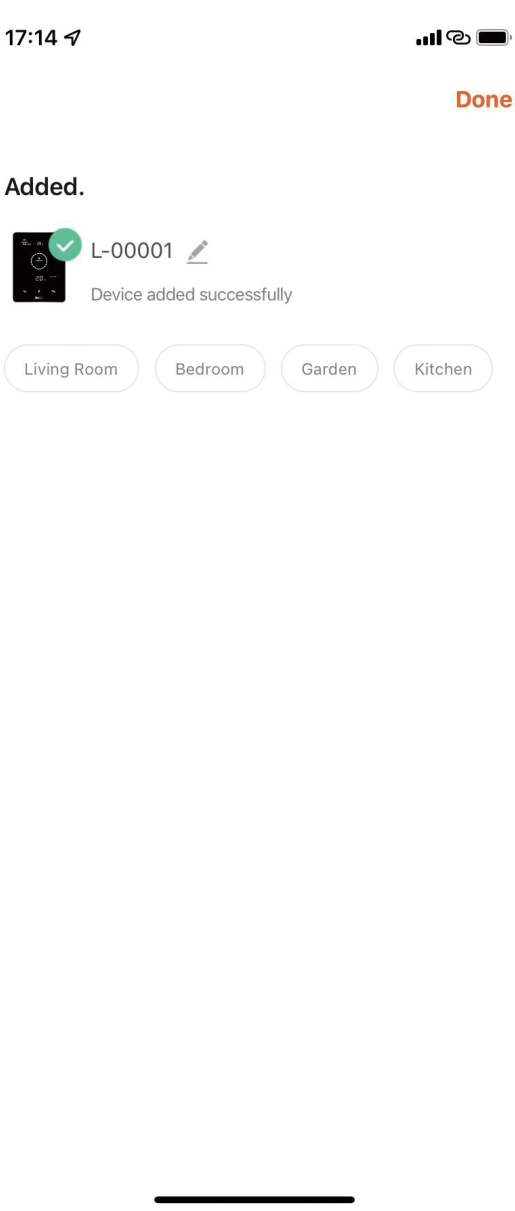
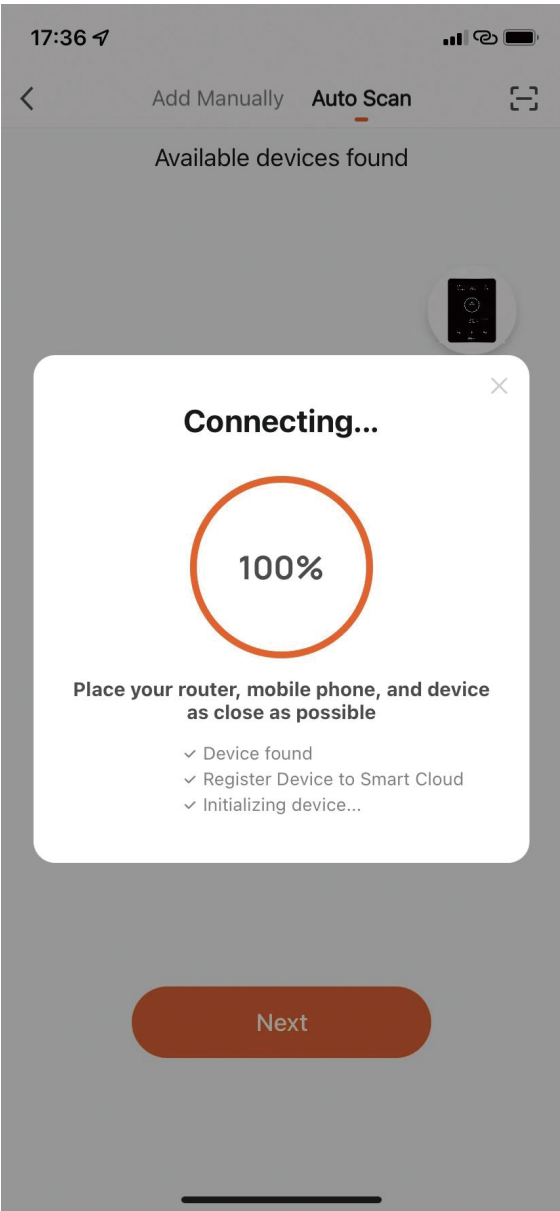

8.2 OTA Upgrade

When upgrade is available, upgrade information will pop up and Tap “Update Now”; Or Tap on the brush icon in the top left corner of the screen to enter the settings screen, and Tap "Device Upgrade" at the bottom to upgrade.

8.3 Device Sharing

Enter the app Settings, tap “Share Device”, and add the mobile number of the corresponding person being shared. By downloading the “InverGo” app, the user being shared can view the device's information simultaneously.

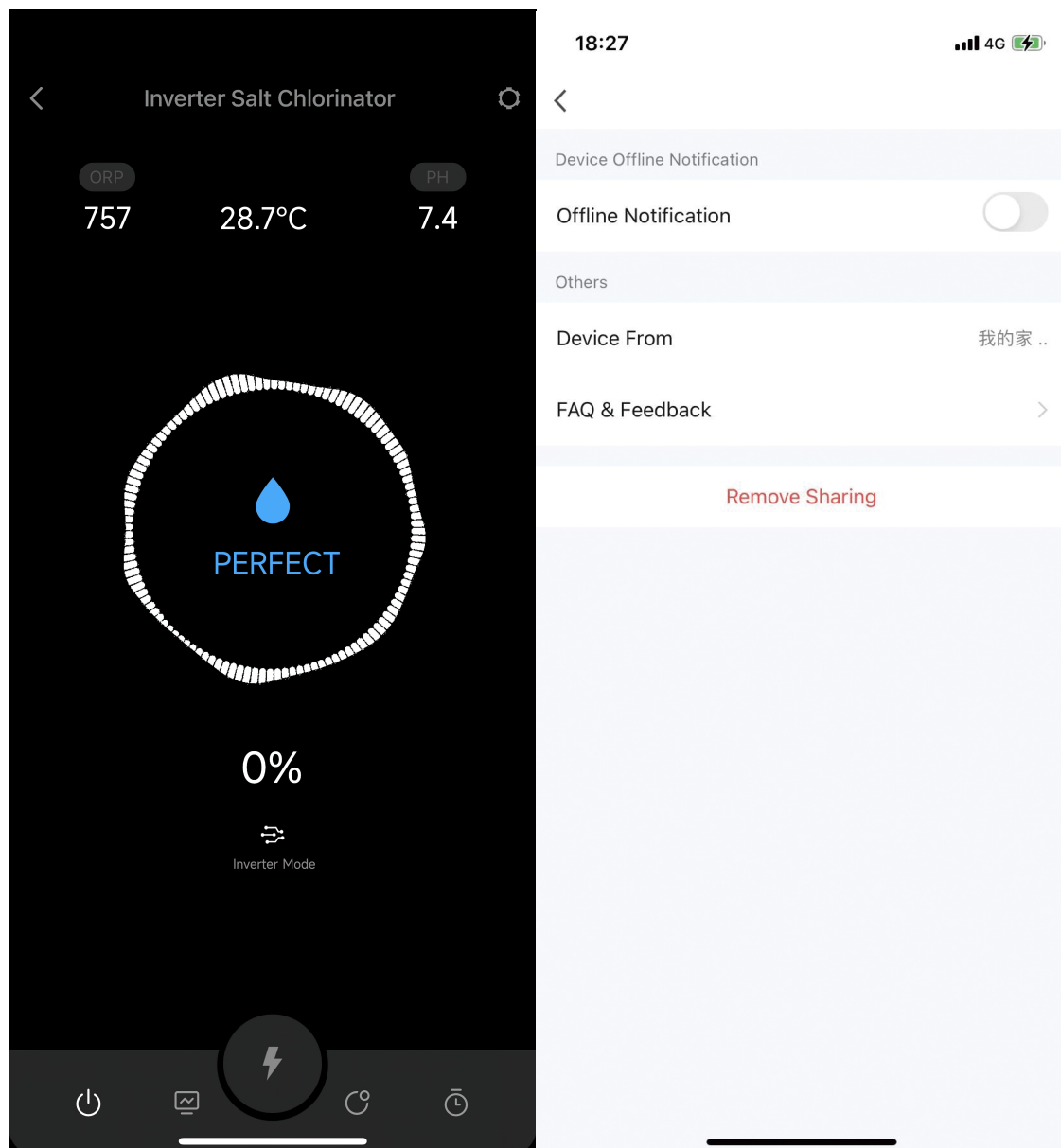

9 Error Code and Solution

Error Code	Reason	Recommended Solution
NO FLOW	<ol style="list-style-type: none"> 1. Filtration pump failure, no flow 2. Water valve closed 3. Flow detection faults 	<ol style="list-style-type: none"> 1. Check filtration pump 2. Check the water valve. 3. Try the following in order: <ul style="list-style-type: none"> - Stop the pump, turn off the chlorinator. - Unplug power cable of the cell, remove the flow switch from the holder. - Turn on the control unit, try to activate the flow switch; If the “NO FLOW” warning remains, replace the flow switch.
ADD SALT	<ol style="list-style-type: none"> 1. Pool salinity below 1000ppm 2. Water temperature too low 3. Electrodes malfunction. 	<ol style="list-style-type: none"> 1. Following warning from control panel, Add salt up to 3000-3500ppm. 2. Check the water temperature 3. Try the following in order: <ul style="list-style-type: none"> Check for excessive scaling on cells and clean. Check if the cells has fallen off the coating or is broken, if so, replace it
ACID TANK	<ol style="list-style-type: none"> 1. Run out of acid. 2. pH Probe not connected/dirty/not calibrated/not working. 	<ol style="list-style-type: none"> 1. Replace with new acid 2. Try the following in order: <ul style="list-style-type: none"> - Check pH probe connections - Clean the probe - Calibrate the probe and test pH value again - Replace probe
CALIBRATE	<ol style="list-style-type: none"> 1. No calibration of the corresponding probe for 3 months 	<ol style="list-style-type: none"> 1. Calibrate the Probe alerted on the control panel; <p>If no calibration performed, hold  until return to the home screen, the warning will disappear automatically</p>
REPLACE	<ol style="list-style-type: none"> 1. Probe dirtied 2. Probe aged 	<ol style="list-style-type: none"> 1. Clean and calibrate Probe. 2. Replace Probe.
E1: Power Supply Abnormal	<ol style="list-style-type: none"> 1. Electrodes disconnected or wrongly connected. 2. Electrodes malfunction. 3. Internal electrical components malfunction. 	<ol style="list-style-type: none"> 1. Check electrodes connection. 2. Check electrodes by following in order: <ul style="list-style-type: none"> Check for excessive scaling on electrolytic plates and clean. Check if the cell has fallen off the coating or is broken, if so, replace it 3. Please contact the After-Sales Center
E2: pH Tuning Failure	<ol style="list-style-type: none"> 1. Have been adding acid for 5 hours but failed to reach targeted pH value. 2. Too much alkalinity, adding acid does not balance the pH 3. pH Probe not connected, dirty, not calibrated or not working 	<ol style="list-style-type: none"> 1. Test pH with other pH testing equipment 2. Reduces alkalinity 3. Try the following in order: <ul style="list-style-type: none"> Check pH probe connections. Clean the probe. Calibrate the probe and test PH again. Replace probe

<p>E3: ORP Tuning Failure</p>	<ol style="list-style-type: none"> 1. Unable to reach targeted ORP value after long time run: <ol style="list-style-type: none"> a. Alarm after 36 hours when pool $\leq 90\text{m}^3$. b. Alarm after 72 hours when pool $> 90\text{m}^3$. 2. Too much cyanuric acid 3. High pH value 4. High chlorine. Chloramine affects ORP Probe testing. 5. Increased resistance between electrodes. 6. ORP Probe not connected, dirty, not calibrated or not working 	<ol style="list-style-type: none"> 1. Test the chlorine level with other chlorine testing device 2. rain some water and fill with fresh water to dilute cyanuric acid. 3. Add Acid to balance pH 4. Choose TURBO mode or add chlorine to reduce chloramine. 5. Check electrolytic if with excessive scaling and clean them. <p>Check if the electrolytic has lost its coating or is broken, if so, replace the electrolytic sheet</p> <ol style="list-style-type: none"> 6. Try the following in order: Check ORP probe connection. Clean the probe. Calibrate the probe and test ORP value. - Replace the probe
<p>E4: Control Unit Overheat</p>	<ol style="list-style-type: none"> 1. The Control Unit is over 70°C, Salt Chlorinator automatically reduces operating speed. 2. Stop operating when the internal of control panel is over 80°C, 	<ol style="list-style-type: none"> 1. Automatically resume normal operation, when the Control Unit is below 70°C <p>Be careful not to install the Salt Chlorinator in a position exposed to direct sunlight, install shade or move the Salt Chlorinator to a sheltered position</p>
<p>E5: Low Temp in Cell</p>	<ol style="list-style-type: none"> 1. Water temperature is below 10°C, Salt Chlorinator automatically reduces operating speed 2. Stop operating when water temperature is below 5°C 	<ol style="list-style-type: none"> 1. Automatically resume normal operation, when water temperature is raised to over
<p>E6: WiFi Connection Failure</p>	<ol style="list-style-type: none"> 1. Weak Wi-Fi signal 2. Internal electrical components malfunction 	<ol style="list-style-type: none"> 1. Check the router Wi-Fi signal 2. Restart the control unit 3. Factory reset 4. Please contact the After-Sales Center
<p>E7: pH Sensor Failure</p>	<ol style="list-style-type: none"> 1. External signal interference 2. Internal electrical components malfunction 	<ol style="list-style-type: none"> 1. Restart the control unit 2. Disconnect the power for 10 seconds and replug the control unit. 3. Factory reset 4. Please contact the After-Sales Center
<p>E8: ORP Sensor Failure</p>	<ol style="list-style-type: none"> 1. External signal interference 2. Internal electrical components malfunction 	<ol style="list-style-type: none"> 1. Restart the control unit 2. Disconnect the power for 10 seconds and replug the control unit. 3. Factory reset 4. Please contact the After-Sales Center
<p>E9: Power Module Failure</p>	<ol style="list-style-type: none"> 1. External signal interference 2. Internal electrical components malfunction 	<ol style="list-style-type: none"> 1. Restart the control unit 2. Disconnect the power for 10 seconds and replug the control unit. 3. Factory reset 4. Please contact the After-Sales Center

AQC000-LO-V1.6